



Installation and servicing instructions

***DIA* 20 MI CE**

***DIA* 24 MI CE**

Type B11bs

Open Flue Appliance

G.C. NUMBER

Produced by **Merloni Termo Sanitari**^{spa} - Italy

**LEAVE THESE INSTRUCTIONS
ADJACENT TO THE GAS METER**

MTS (GB) LIMITED
MTS Building, Hughenden Avenue, High Wycombe
Bucks HP 13 5FT
Telephone (01494) 459711 - Fax (01494) 459775

TABLE OF CONTENTS

Sect.	Subject	Page No.	Sect.	Subject	Page No.
1	GENERAL INFORMATION		6.16	Gas modulator coil	27
1.1	Overall view	2	6.17	On-off operator coils	27
1.2	Technical data	3	6.18	Gas valve	27
1.3	Available pump head	5	6.19	Main heat exchanger	27
1.4	Design principles and operating sequence	5	6.20	Flue control probe	28
			6.21	Automatic air purger	28
			6.22	Pump	28
2	GENERAL REQUIREMENTS		6.23	Pump pressure switch	29
2.1	Related documents	7	6.24	Temperature pressure gauge	29
2.2	Boiler location	7	6.25	Removing divertor valve	30
2.3	Air supply	7	6.26	Secondary exchanger	30
2.4	Products of combustion	7	6.27	Expansion vessel	30
2.5	Extract fans	7	6.28	Safety valve	30
2.6	Timber frame buildings	7			
2.7	Gas supply	7	7	FAULT FINDING	
2.8	Flue system	8	7.1	Total check system	31
2.9	Water circulation	8	7.2	Special defects	31
2.10	Domestic water	9	7.2.1	Water leaks	31
2.11	Electrical supply	9	7.2.2	Difficulty in lighting the burner	31
			7.2.3	Incorrect combustion	32
3	INSTALLATION		7.2.4	Traces of gas or exhaust flues	32
3.1	Delivery	10	7.3	Installation of the TCS	32
3.2	Measurements for installing the appliance	10	7.4	Fault finding	32
3.3	Unpacking the boiler	11	7.5	Fault finding without the utilization of the total check system	45
3.4	Positioning of the boiler	11	7.5.1	Appliance completely shut down	45
3.5	Electrical connections	13	7.5.2	Appliance fail frequently ignition with consequent lockout (red light on the reset push button)	47
			7.5.3	Fault on "hot water-space heating" switching	48
4	COMMISSIONING		8	ELECTRIC DIAGRAMS	
4.1	Electrical installation	15	8.1	Electrical connection	49
4.2	Gas supply installation	15	8.2	Functional flow connection	50
4.3	Filling the d.h.w. system	15			
4.4	Initial filling of the system	15	9	SHORT SPARE PARTS LIST	51
4.5	Setting the system pressure	16	.	Control panel	
4.6	Lighting the boiler	16	.	Residual head of circulator	
4.7	Checking the full sequence control	16	.	Regulating heating power for Natural Gas (G20)	
4.8	Testing the d.h.w. system flow	16	.	Regulating heating power for Butane Gas (G30)	
			.	Regulating heating power for Propane Gas (G31)	
5	MAINTENANCE				
5.1	General	17			
5.2	Recommended routine maintenance	17			
6	SERVICING INSTRUCTIONS				
6.1	Replacement of parts	18			
6.2	To gain general access	18			
6.3	To drain the main circuit of the boiler	19			
6.4	To drain the d.h.w. circuit of the boiler	19			
6.5	Setting gas pressure	19			
6.6	Overheat thermostat	21			
6.7	Removing ignition electrodes	21			
6.8	Removing flame sensor	22			
6.9	Removing d.h.w. and c.h.w. potentiometers	23			
6.10	Removing d.h.w. sensor probe	24			
6.11	Removing c.h.w. sensor probe	24			
6.12	Microswitches on divertor valve	25			
6.13	Burner and injectors	25			
6.14	Insulations panel	26			
6.15	Gas modulator cartridge	26			

*Dear customer,
Thank you for choosing an ARISTON combination boiler.
We guarantee that your boiler is a reliable and technically sound product.
This Owner's manual provides detailed instructions and recommendations for proper installation, use and maintenance.
Remember to keep this manual in a safe place for future reference i.e. by the gas meter.
Your local MTS Servicing Centre is at your complete disposal for all your requirements.*

MTS (GB) LIMITED



GUARANTEE

The guarantee on this appliance is valid for 12 months from the date of installation.
Repairs to the electric, hydraulic or gas circuits may be carried out only by your local authorized MTS Servicing Centre.

Despite every attempt has been made to avoid errors of any kind in this Owner's Manual, the Management invites customers to report any inaccuracies which they may find. Your comments will help to improve our service.

IMPORTANT INSTRUCTIONS

Read the instructions and recommendations in this owner's manual carefully to ensure proper installation, use and maintenance of the appliance.

Keep this owner's manual in a safe place. You may need it for your own reference while our Servicing Centre technicians or your installer may need to consult it in the future.

WARNING

This appliance is designed to produce hot water. It must be connected to a central heating system or to hot water mains system suited to its specifications and capacity.

This appliance **MUST BE USED ONLY** for the purpose for which it is designed.

The manufacturer declines all liability for damage caused by improper or negligent use.

BEFORE CONNECTING the appliance check that the information shown on the data plate and the table on pages 4-5 comply with the electric, water and gas mains of your home.

You will find the data plate on the control panel.

The gas with which this appliance operates is also shown on the label at the bottom of the boiler.

DO NOT install this appliance in a damp environment or close to equipment which spray water or other liquids.

DO NOT PLACE objects on the appliance.

DO NOT ALLOW children or inexperienced persons to use the appliance without supervision.

If you smell gas in the room, **DO NOT TURN ON** light switches, use the telephone or any other object which might cause sparks.

Open doors and windows immediately to ventilate the room. Shut the gas mains tap (on the gas meter) or the valve of the gas cylinder and call your Gas Supplier immediately.

If you are going away for a long period of time, remember to shut the mains gas tap or the gas cylinder valve.

ALWAYS DISCONNECT the appliance either by unplugging it from the mains or turning off the mains switch before cleaning the appliance or carrying out maintenance.

IN THE CASE OF FAULTS OR FAILURE, switch off the appliance and turn off the gas tap. Do not tamper with the appliance.

For repairs, call your local Authorized Servicing Centre and request the use of original spare parts.

For in guarantee repairs contact MTS (GB) LIMITED

NEVER block the ventilation outlet of the compartment in which the boiler is installed with rags or paper.

CHECK the following at least once a year:

- 1 -Check the seal of water connections, replacing the gaskets if necessary.
- 2 -Check the seal of the gas connections, replacing the gaskets if necessary.
- 3 -Check the general condition of the appliance and of the combustion chamber visually
- 4 -Visual check of the combustion: clean burners if necessary.
- 5 -With reference to point 3, dismount and clean the combustion chamber if necessary.
- 6 -With reference to point 4, dismount and clean the injectors if necessary.
- 7 -Visual check of the primary heat exchanger:
 - check for overheating of the exchangers fins;
 - clean the fume side of the exchanger if necessary.
- 8 -Regulate the gas pressure, ignition pressure, partial flame, maximum flame.
- 9 -Check proper operation of the heating safety system:
 - maximum safety temperature;
 - maximum safety pressure.
- 10 -Check the proper operation of the gas safety system:
 - gas or flame safety device;
 - gas valve safety device.
- 11 -Check that the electric connections have been made in compliance with the instructions shown in the owner's manual.
- 12 -Check the efficiency of the hot water supply (flow and temperature).
- 13 -General operating check of the appliance.
- 14 -Check room ventilation.
- 15 -Check the exhaust system for the combustion products.

**FAILURE
TO FOLLOW THE
ABOVE INSTRUCTIONS
MAY COMPROMISE
THE SAFETY OF THE
APPLIANCE**

1 GENERAL INFORMATION

1.1 OVERALL VIEW

GB950063

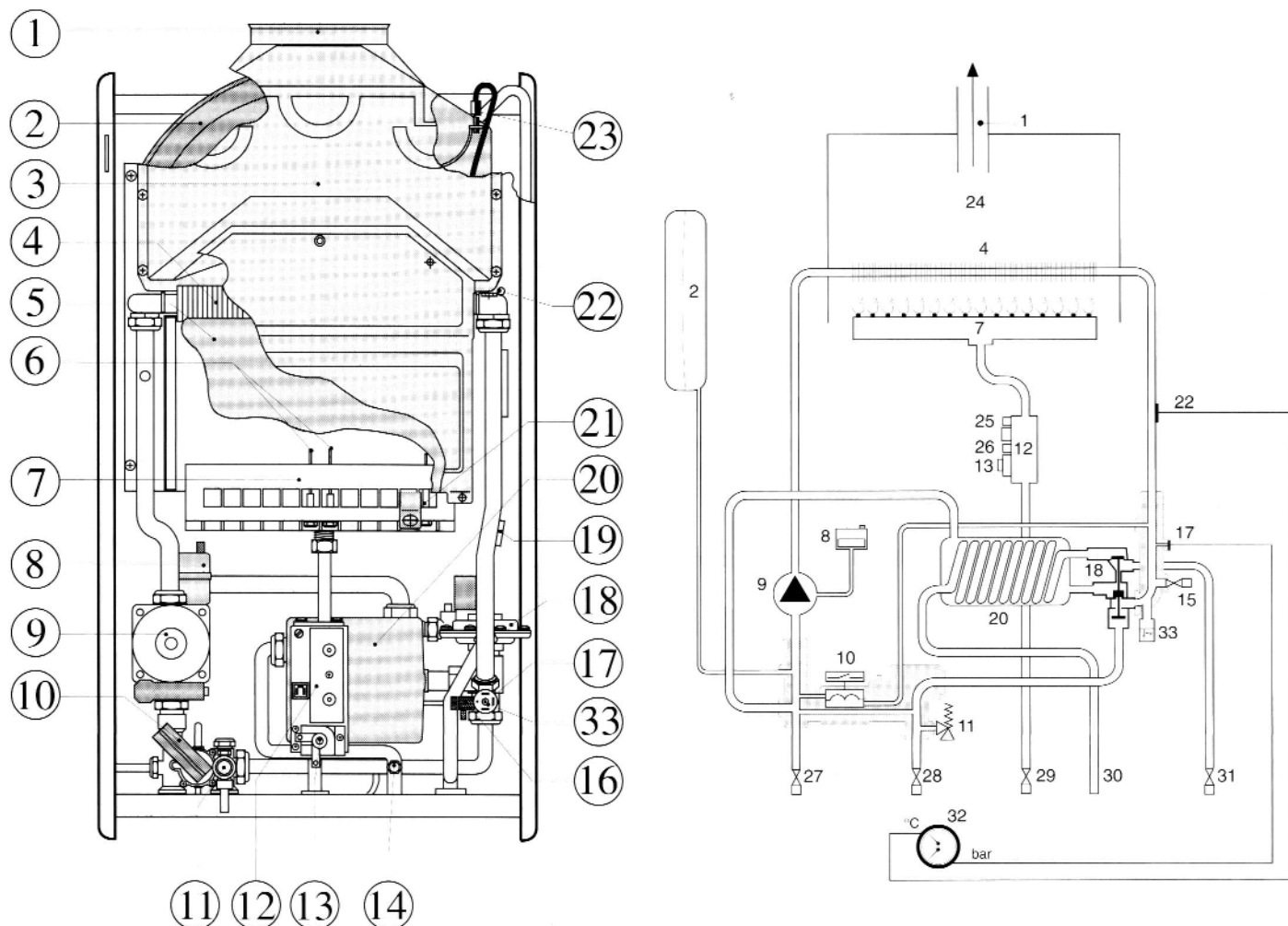

- 1 - Flue hood
- 2 - Expansion vessel
- 4 - Main heat exchanger
- 5 - Combustion chamber insulation panel
- 6 - Ignition electrodes
- 7 - Main burner
- 8 - Automatic air release valve
- 9 - Pump
- 10 - Main circuit flow switch
- 11 - Safety valve
- 12 - Gas valve
- 13 - Gas modulator
- 14 - D.h.w. temperature probe
- 16 - C.h. drain cock
- 17 - Heating temperature probe
- 18 - Divertor valve
- 19 - Thermometer probe
- 20 - Secondary exchanger

- 21 - Detection electrode
- 22 - Overheat thermostat probe
- 23 - Flue control probe
- 24 - Combustion chamber
- 25 - Pressure test point for measuring outlet pressure at the gas valve⁽¹⁾
- 26 - Pressure test point for measuring inlet pressure at the gas valve⁽¹⁾
- 27 - C.h.w. (central heating water) return
- 28 - C.h.w. flow
- 29 - Gas inlet
- 30 - D.h.w. (domestic hot water) outlet
- 31 - D.w. inlet
- 32 - Water pressure/temperature gauge
- 33 - Pump pressure switch

(1) Gas valve components.

General information

1.2 TECHNICAL DATA

Model DIA 20 MI CE

The ARISTON DIA 20 MI CE is a combined central heating (c.h.) and domestic hot water (d.h. w.) appliance.

It is produced as a room opened category appliance suitable for wall mounting applications only.

This boiler is suitable only for sealed systems.

Heating input	max	25.6 kW	87364 Btu/h
Heating input	min	11.0 kW	37539 Btu/h
Heating output	max	23.1 kW	78832 Btu/h
Heating output	min	8.8 kW	30031 Btu/h

CENTRAL HEATING

Operating temperature	max	85 °C	
Operating temperature	min	45 °C	
Working pressure	max	2.5 bar	36.25 p.s.i.
Water content		2.7 lts	0.6 gals.
Built-in expansion vessel - Total capacity		7 lts	1.53 gals.
Built-in expansion vessel - Pre-charge pressure		1 bar	14.5 p.s.i.
Available head at 1000 lts./h (220 gals./h)		2.50 m w.g.	98.42 ins w.g.
Temp. difference for flow and return		20 °C	
Flow rate of water through the appliance		1000 lts./h	219.3 gals./h
Max permissible cold water capacity without additional expansion vessel ⁽¹⁾		70 lts./h	15.3 gals./h

DOMESTIC HOT WATER

Working pressure	max	6 bar	87 p.s.i.
Working pressure	min	0.2 bar	2.9 p.s.i.
Water content		0.30 lts	0.08 gals.
Flow rate	min	2.4 lts./min	0.5 gals./min
Flow rate	30 °C rise	11.0 lts./min	2.4 gals./min
Flow rate	35 °C rise	9.5 lts./min	2.1 gals./min
Flow rate	40 °C rise	8.3 lts./min	1.8 gals./min

COMPONENT DETAILS

Gas control valve	SIT 837 TANDEM
Burner	Atmosferic steel - POLIDORO

ELECTRICAL DATA

Electrical supply	230 V
Frequency	50 Hz
Power consumption	100 W
Internal fuse rating	2 A

CONNECTIONS

Gas connection	15 mm o.d.
C.h. flow	22 mm o.d.
C.h. return	22 mm o.d.
D.c.w. inlet	15 mm o.d.
D.h.w. outlet	15 mm o.d.
Safety discharge pipe	15 mm o.d.

FLUE PIPES SPECIFICATIONS

Outer diameter	140 mm	5.5 ins
----------------	--------	---------

OTHER SPECIFICATIONS

Height	895 mm	35.2 ins
Width	480 mm	18.9 ins
Depth	360 mm	14.1 ins
Dry weight	43 Kg	95 lbs

GAS REQUIREMENTS		NATURAL GAS (G20)		BUTANE GAS (G30)		PROPANE GAS (G31)	
Gas rate	max	2.7 m ³ /h	96.0 ft ³ /h	0.8 m ³ /h	28.2 ft ³ /h	1.0 m ³ /h	36.5 ft ³ /h
Gas rate	min	1.1 m ³ /h	38.8 ft ³ /h	0.3 m ³ /h	10.6 ft ³ /h	0.4 m ³ /h	14.7 ft ³ /h
Inlet pressure		20 mbar	7.8 in w.g.	28 mbar	10.9 in w.g.	37 mbar	14.4 in w.g.
Burner pressure (Natural gas)	max	12.3 mbar	4.8 in w.g.	28 mbar	10.9 in w.g.	37 mbar	14.4 in w.g.
Burner pressure (Natural gas)	min	2.0 mbar	0.8 in w.g.	5.1 mbar	2.0 in w.g.	7.0 mbar	2.7 in w.g.
Burner injectors		13 x 1.25		13 x 0.72		13 x 0.72	

(1) If required an external expansion vessel can be fitted

General information

1.2 TECHNICAL DATA

Model DIA 24 MI CE

The ARISTON DIA 24 MI CE is a combined central heating (c.h.) and domestic hot water (d.h. w.) appliance.

It is produced as an open flue category appliance suitable for wall mounting applications only.

This boiler is suitable only for sealed systems.

Heating input	max	29.8 kW	102810 Btu/h
Heating input	min	12.0 kW	41400 Btu/h
Heating output	max	27.0 kW	93150 Btu/h
Heating output	min	10.1 kW	34845 Btu/h

CENTRAL HEATING

Operating temperature	max	85 °C	
Operating temperature	min	45 °C	
Working pressure	max	2.5 bar	36.25 p.s.i.
Water content		2.7 lts	0.6 gals.
Built-in expansion vessel - Total capacity		7 lts	1.53 gals.
Built-in expansion vessel - Pre-charge pressure		1 bar	14.5 p.s.i.
Available head at 1000 lts./h (220 gals./h)		3.0 m w.g.	118.1 ins w.g.
Temp. difference for flow and return		20 °C	
Flow rate of water through the appliance		1200 lts./h	264 gals./h
Max permissible cold water capacity without additional expansion vessel ⁽¹⁾		70 lts./h	15.3 gals./h

DOMESTIC HOT WATER

Working pressure	max	6 bar	87 p.s.i.
Working pressure	min	0.2 bar	2.9 p.s.i.
Water content		0.30 lts	0.08 gals.
Flow rate	min	2.4 lts./min	0.5 gals./min
Flow rate	30 °C rise	13 lts./min	2.8 gals./min
Flow rate	35 °C rise	11.5 lts./min	2.5 gals./min
Flow rate	40 °C rise	9.8 lts./min	2.1 gals./min

COMPONENT DETAILS

Gas control valve	SIT 837 TANDEM
Burner	Atmosferic steel - POLIDORO

ELECTRICAL DATA

Electrical supply	230 V
Frequency	50 Hz
Power consumption	130 W
Internal fuse rating	2 A

CONNECTIONS

Gas connection	15 mm o.d.
C.h. flow	22 mm o.d.
C.h. return	22 mm o.d.
D.c.w. inlet	15 mm o.d.
D.h.w. outlet	15 mm o.d.
Safety discharge pipe	15 mm o.d.

FLUE PIPES SPECIFICATIONS

Outer diameter	140 mm	5.5 ins
----------------	--------	---------

OTHER SPECIFICATIONS

Height	895 mm	35.2 ins
Width	480 mm	18.9 ins
Depth	360 mm	14.1 ins
Dry weight	43 Kg	95 lbs

GAS REQUIREMENTS		NATURAL GAS (G20)		BUTANE GAS (G30)		PROPANE GAS (G31)	
Gas rate	max	2.7 m ³ /h	96.0 ft ³ /h	0.8 m ³ /h	28.2 ft ³ /h	1.0 m ³ /h	36.5 ft ³ /h
Gas rate	min	1.1 m ³ /h	38.8 ft ³ /h	0.3 m ³ /h	10.6 ft ³ /h	0.4 m ³ /h	14.7 ft ³ /h
Inlet pressure		20 mbar	7.8 in w.g.	28 mbar	10.9 in w.g.	37 mbar	14.4 in w.g.
Burner pressure (Natural gas)	max	11.5 mbar	4.5 in w.g.	28 mbar	10.9 in w.g.	37 mbar	14.4 in w.g.
Burner pressure (Natural gas)	min	2.0 mbar	0.8 in w.g.	5.1 mbar	2.0 in w.g.	7.0 mbar	2.7 in w.g.
Burner injectors		13 x 1.25		13 x 0.72		13 x 0.72	

(1) If required an external expansion vessel can be fitted

(2) Using one or more horizontally elongated flue pipes kits (see sect. 1.4)

General information

1.3 AVAILABLE PUMP HEAD

The curve on the internal end cover shows the water pressure (head) available to the central heating (c.h.) circuit as a function of flow; the load loss of the appliance has already been subtracted.

1.4 DESIGN PRINCIPLES AND OPERATING SEQUENCE

Water system design

The basic purpose of a boiler is to generate heat through the combustion of gas and to direct the heat through a water circuit.

A combination-type appliance allows the heat to be used either for heating the environment or for heating hot water for domestic use.

Main water circuit

This is an internal water circuit in the appliance which passes through the main heat exchanger and absorbs heat directly from the combustion of gas. The water in this circuit is the same water that is circulated by the pump and flows through the c.h. system.

The direction of the water in the main water circuit can be changed by a diverter valve. The main water circuit is connected to the c.h. circuit during operation with the c.h. system (see fig. 1.2)

When d.h.w. is required, the main water circuit is directed through the d.h.w. heat exchanger via the diverter valve (see fig. 1.3).

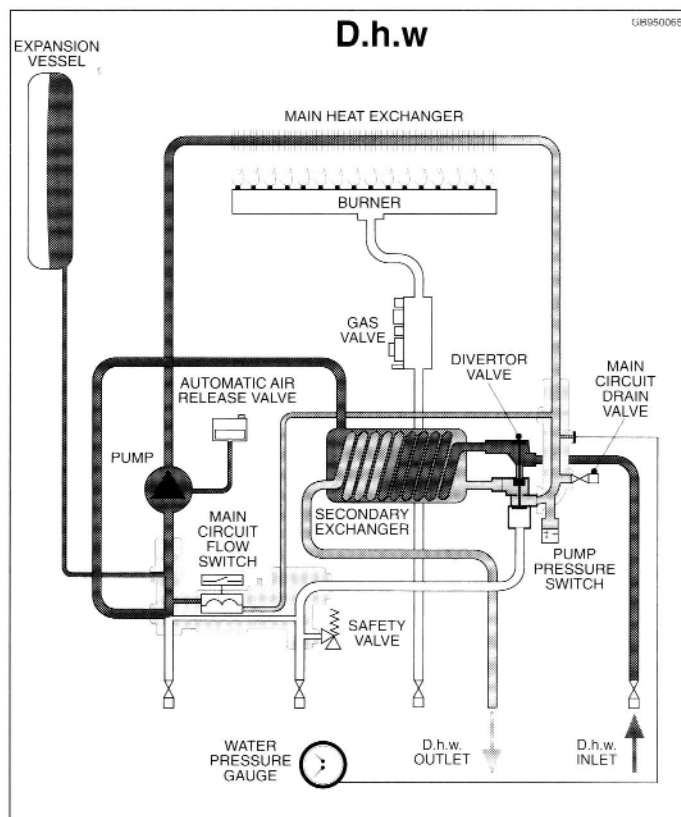

fig. 1.3

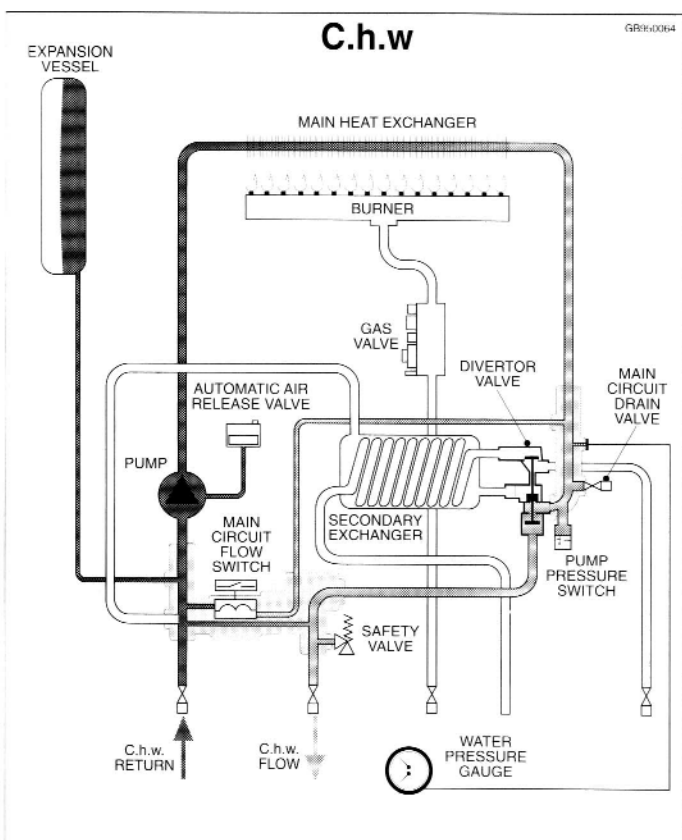

fig. 1.2

Safety device

If the flow rate in the main water circuit is insufficient, the flow switch on main water circuit disconnects the supply to the full sequence control p.c.b.

In this case the boiler is turned off in order to prevent damage. An overheat thermostat disconnects the two ON-OFF operators on the gas valve; as a result, the burner is shut down. Only by a manual reset is possible to light again the burner (if temperature is correct).

A safety valve is provided to relieve excess pressure from the main circuit.

The appliance is fitted with flue control probe, which will prevent the boiler from functioning if there is spillage of flue gases.

If the air pressure switch does not detect the correct velocity, the burner will shut down.

Operating sequence on central heating mode

The function switch must be set on position III' .

The water in the main circuit is sent to the c.h. system when the diverter valve is in the c.h. position.

In this configuration, the diverter is in the normal position and the d.h.w. heat exchanger circuit is cut out.

The appliance is controlled by an electronic thermostat; water delivery temperature can be adjusted from 35° C to 85° C.

General information

The lighting cycle begins with a spark from the ignition electrodes; at the same time, electrical power is fed to the two ON-OFF operators on the gas valve.

If the flame detection electrode does not sense the flame within 7 seconds from the beginning of the cycle, the full sequence control p.c.b. interrupts the lighting cycle, the electric sparks are shut off and the power is disconnected from the two ON-OFF operators on the gas valve.

At this point, the shut down warning light appears and the reset push-button must be pressed to restart the lighting cycle.



If the detection electrode senses flame within 7 seconds from the beginning of the cycle, the full sequence control p.c.b. interrupts the electrical sparks.

At the same time, the temperature of the heating circuit is measured by the main circuit temperature probe and this temperature is compared with the value set on the c.h. temperature adjustment (III °C).

After lighting has been accomplished, the flow from the gas valve is determined by the electronic regulation p.c.b. :

- When the temperature of the circuit heating water (c.h.w.) is 5°C (or more) under the preset temperature, the appliance will supply its maximum preset power .
- When the temperature of the circuit heating water (c.h.w.) is just few degrees under (<5°C) the preset-temperature, the appliance will supply its minimum pre-set power (that corresponds to 35% of the maximum rated power).

D.h.w. only operation

When the function switch is set on position  the c.h. adjustment system is deactivated, the diverter valve is actuated and the shutter diverts water delivery to the d.h.w. heat exchanger. When d.h.w. is drawn from the d.h.w. system, the appliance operates in the same way as when the function switch set on position III .

2 GENERAL REQUIREMENTS

This appliance must be installed by a competent installer in accordance with the 1984 Gas Safety (installation & use) Regulations (as amended).

2.1 RELATED DOCUMENTS

The installation of this appliance must be in accordance with the relevant requirements of the 1984 Gas Safety (installation & use) Regulations, the Local Building Regulations, the current I.E.E. Wiring Regulations, the by laws of the local water undertaking, and in Scotland, in accordance with the Building Standards (Scotland) Regulation. Health and safety document n° 635 "Electricity at work regs. 1989".

Installation should also comply with the following British Standard Codes of Practice:

Low pressure pipes	BS 6891	1988
Boilers of rated input not exceeding 60 kW	BS 6798	1987
Forced circulation hot water system	BS 5449	1990
Installation of gas hot water supplies for domestic purposes (2 nd family gases)	BS 5546	1990
Flues	BS 5540-1	1990
Air supply	BS 5540-2	1989

Some else recommendations are contained in the current issue of the following british standard specifications:

Codes of practice	BS 5440 Part. 1 and 2
	BS 6700
	BS 4814
	BS 7074 Part. 1 and 2 as applicable
	BS 5482 Part. 1

2.2 BOILER LOCATION

WARNING!

A boiler operating on LPG MUST NOT be installed in a basement or below ground level.

This boiler is not suitable for out of doors location.

This is an open flued boiler and must not be installed in a bedroom, bedsitting room or a room containing a bath or shower.

Open flued boilers must not be installed in private garages. Where the installation of the boiler will be in an unusual location, special procedures are necessary, refer to the current issue of BS6798 for guidance.

A compartment used to enclosed the boiler must be designed and constructed specifically for this purpose.

An existing cupboard or compartment modified for the purpose may be used, refer to the current issue of BS6798 for guidance.

The doorway opening should be of sufficient size to allow for easy removal of the boiler.

Be provided with permanent ventilation openings as shown in Table below. These figures are for the minimum free area.

The high and low level openings must communicate with the same room or space or must both be on the same wall to outside air.

The compartment door or vent should not communicate with a bedroom, bed sitting room or a room containing a bath or shower.

Air Vent Position		Minimum Vent Area	
		Air from room or internal space	Air direct from outside
High Level	DIA 20 MI CE	230 cm ² (35.6 in ²)	115 cm ² (17.8 in ²)
	DIA 24 MI CE	268 cm ² (41.5 in ²)	134 cm ² (20.7 in ²)
Low Level	DIA 20 MI CE	461 cm ² (71.5 in ²)	231 cm ² (35.8 in ²)
	DIA 24 MI CE	537 cm ² (83 in ²)	268 cm ² (41.5 in ²)

2.3 AIR SUPPLY

A purpose designed ventilation opening must be fitted on an outside wall of the building, this opening may be either, directly into the room or space containing the boiler, or into an adjacent room or space which has an internal permanent air vent of the same size to the room containing the boiler.

Do not ventilate through a kitchen, bathroom or toilet.

Vents through a cavity wall must be ducted.

If there are other fuel burning appliances present allowance must be made for their combustion requirements.

The minimum free area for the boiler are:

DIA 20 MI CE	16 in ²
DIA 24 MI CE	20 in ²

2.4 PRODUCTS OF COMBUSTION

Test the boiler for clearance of flue products at the draught driver as detailed in the current issue of BS5440 Part.1.

2.5 EXTRACT FANS

If an extract fan is fitted there is a possibility that if adequate air is not provided spillage of the flue products could occur. If vents are fitted in accordance with the above recommendation this should not occur.

However, where such an installation is found a spillage test must be carried out as detailed in the current issue of BS5400 Part.1 and any necessary action taken.

2.6 TIMBER FRAME BUILDINGS

If the boiler is to be installed in a timber frame building it should be fitted in accordance with the British Gas publication "Guide for Gas Installation in Timber Framed Housing", reference DM2. If in any doubt, seek advice from the local gas undertaking or Hepworth Heating Ltd.

2.7 GAS SUPPLY

The gas installation, for natural gas and LPG shall be in accordance with the current issue of BS6891.

For natural gas the supply from the governed meter must provide a steady inlet pressure at the boiler of 20mbar (8in wg).

For LPG requirements refer to the current issue of BS5482.

General requirements

On completion test the gas installation for soundness using the pressure drop method and a suitable leak detection fluid, purge in accordance with the above standard.

2.8 FLUE SYSTEM

The integral draught diverter makes the combustion performance independent of the conditions in the secondary flue, but an efficient flue is necessary to ensure a trouble free installation.

The flue must be installed in accordance with the recommendation in the current issue of BS5440 Part 1.

The flue diameter required must not be less than that given below, a flue collar is supplied with the boiler to ease the connection of this size of flue.

Model	Flue Diameter
DIA 20 MI CE	125 mm (5in) - 140 mm (5.5in)
DIA 24 MI CE	140 mm (5.5in)

The flue should be kept as short as possible, horizontal or very shallow runs should be avoided.

Give maximum possible vertical rise from the boiler, minimum 600mm (24in) before any bend.

The use of 45° bends is recommended.

End with an approved terminal, above ridge height, if possible, if not, at least above the eaves of a pitched roof.

A previously used chimney must be swept and any register plate, damper or the like must be removed and the chimney made good, before lining with an approved chimney liner.

2.9 WATER CIRCULATION (Central heating)

Detailed recommendations are given in BS 6798-1987 and BS 5449-1 1990; the following notes are given for general guidance.

Pipework

Copper tubing to BS 2871-1 1977 is recommended for water pipes. Jointing should be either with capillary soldered or compression fittings.

Where possible pipes should have a gradient to ensure air is carried naturally to air release points and water flows naturally to drain taps.

The appliance has a built-in automatic air release valve; it should be ensured as far as possible that the appliance heat exchanger is not a natural collecting point for air.

Except where providing useful heat, pipes should be insulated to prevent heat loss and avoid freezing.

Particular attention should be paid to pipes passing through ventilated spaces in roofs and under floors.

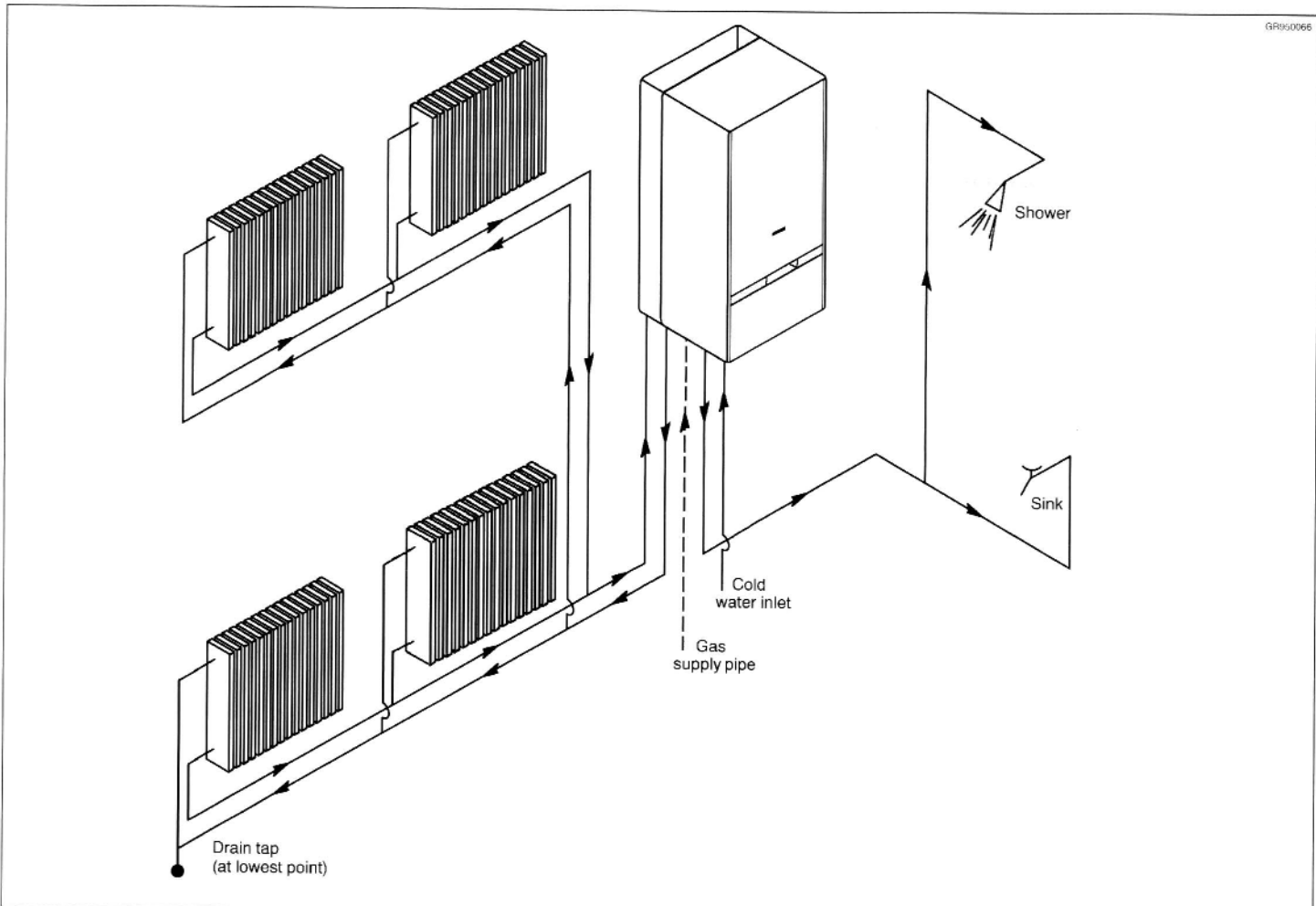

fig. 2.1

General requirements

Installation of by-pass

The installation of a by-pass is not required if radiators have been equipped with thermostatic valves because a permanent by-pass is inside the boiler yet.

System design

This boiler is suitable only for sealed systems. A typical lay-out is illustrated in fig. 2.1.

Drain cocks

These must be located in accessible positions to permit the draining of the whole system. The taps must be at least 15 mm nominal size and manufactured in accordance with BS 2870-1980.

Air release points

These must be fitted at all high points where air naturally collects and must be sited to facilitate complete filling of the system.

The appliance has an integral sealed expansion vessel to accommodate the increase of water volume when the system is heated.

It can accept up to 7 lts (1,5 gals.) of expansion water. If the heating circuit has an unusually high water content, calculate the total expansion and add additional sealed expansion vessel with adequate capacity.

Mains water feed: central heating

No direct connection to the mains water supply even through a non return valve, may be made without the approval of the Local Water Authority.

Filling

A method for initially filling the system and replacing water lost during servicing must be provided and it must comply with local water authority regulations.

A possible method is shown in fig. 2.2.

The installer should ensure that no leaks exist as frequent filling of the system could cause premature scaling of the heat exchanger.

2.10 DOMESTIC WATER

The domestic water must be in accordance with the relevant recommendations of BS 5546. Copper tubing to BS 2871-1 is recommended for water carrying pipework and must be used for pipework carrying drinking water.

2.11 ELECTRICAL SUPPLY

Warning, this appliance must be earthed.

External wiring to the appliance must be carried out by a qualified technician and be in accordance with the current I.E.E. Regulations and applicable local regulations .

The ARISTON DIA MI CE is supplied for connection to a 230 V- 50 Hz supply.

The supply must be fused at 3 A.

The method of connection to the electricity supply must facilitate complete electrical isolation of the appliance by the use of a fused double pole isolator having a contact separation of the least 3 mm in all poles or alternatively, by

means of a 3 A fused three pin plug and unswitched shuttered socket outlet both complying with BS 1363. The point of connection to the Electricity supply must be readily accessible and adjacent to the appliance unless the appliance is installed in bathroom when this must be sited outside the bathroom.

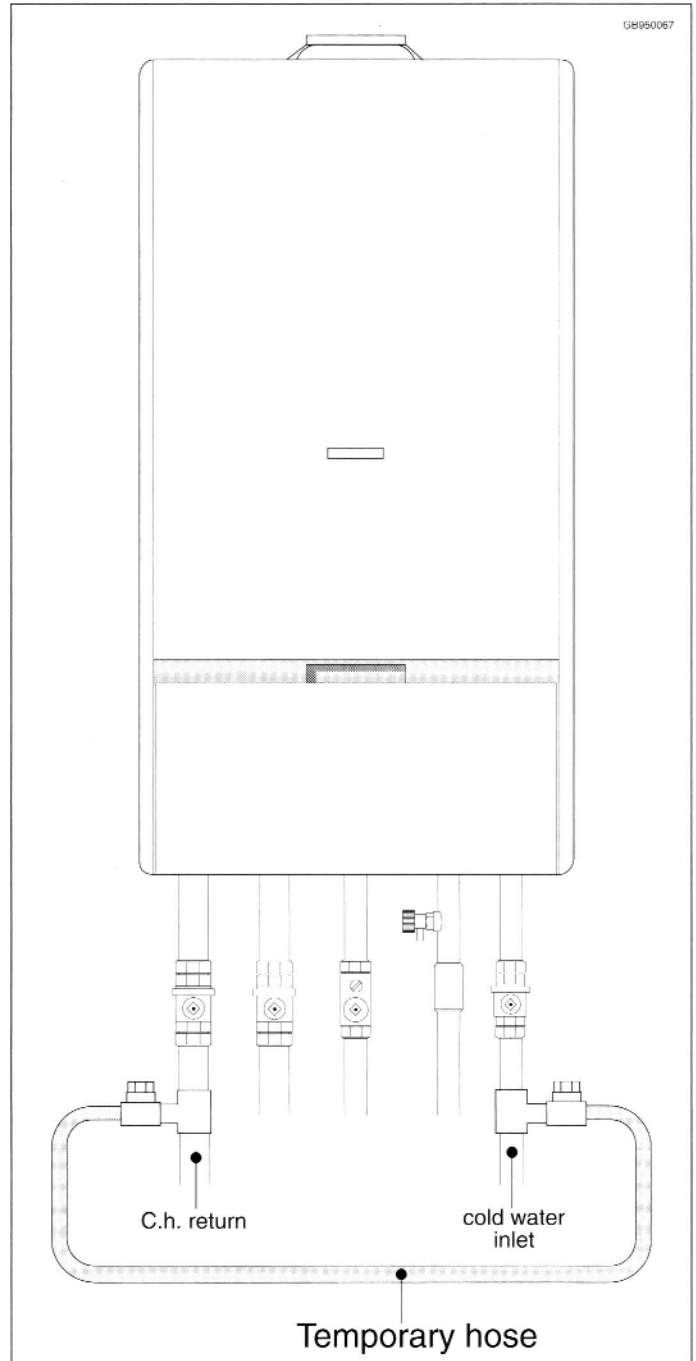

fig. 2.2

3 INSTALLATION

Category B11bs are open flue appliances so equipped to be connected to an exhaust pipe which goes outside of the house. The flue is natural draught.

Moreover, these type of appliances are equipped with a special device which continually checks their correct operation. These type of appliances cannot be installed inside a room which is not comply with room ventilation laws now in force.

3.1 DELIVERY

There will be 1 item:

1- The fully assembled boiler; including Fitting Pack

3.2 MEASUREMENTS FOR INSTALLING THE APPLIANCE

Model DIA 20/24 MI CE

IMPORTANT!

To allow easy access to the interior of the boiler for maintenance work, keep to the minimum dimensions shown in the drawing (see fig. 3.2).

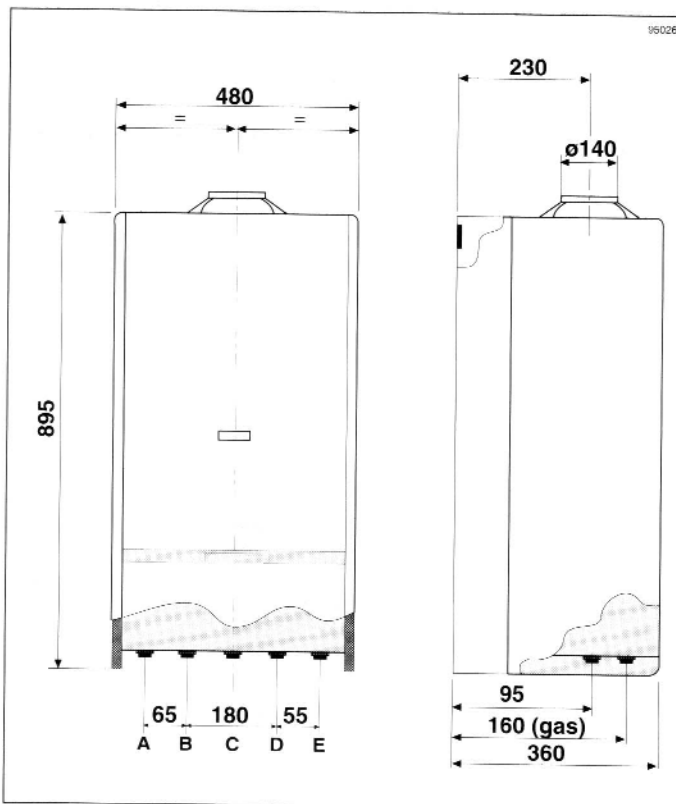

- A: C.h.w. return
- B: C.h.w. flow
- C: Gas inlet
- D: D.h.w. outlet
- E: D.w. inlet

fig. 3.1

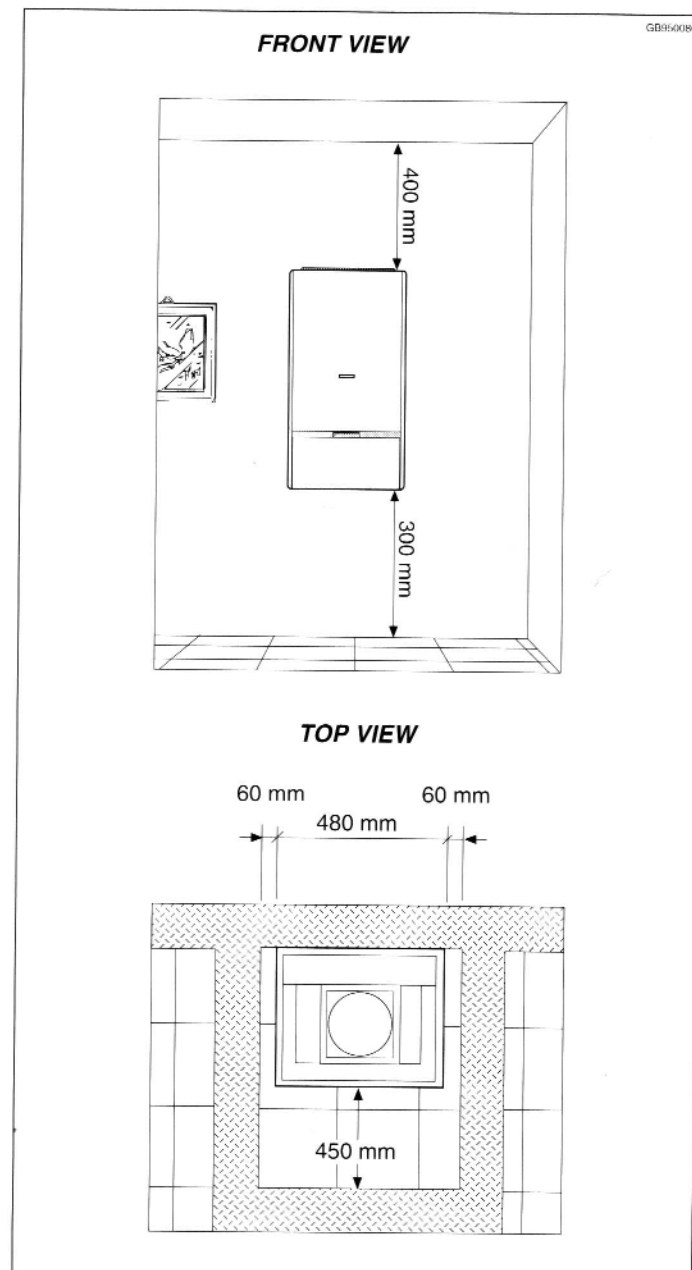

fig. 3.2

Installation

3.3 UNPACKING THE BOILER

(see fig. 3.3)

1- Turn the carton upsidedown and open;

2- Turn the carton right way up;

3- Remove the carton;

4- Remove valves pack, documentation and all polystyrene packing.

IMPORTANT!

All of the boiler packaging (carton and polystyrene) is fully recyclable.

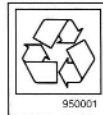

IMPORTANT!

All packaging must be properly and thoroughly disposed. Some components (i.e.: polythene, staples etc.) could prove to be dangerous to young children.

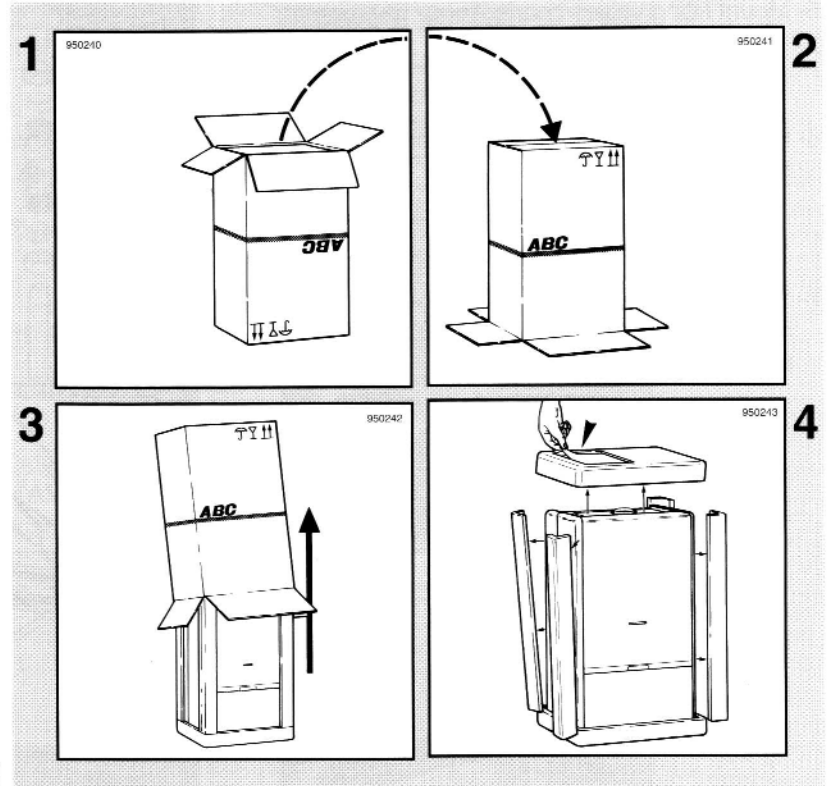

fig. 3.3

3.4 POSITIONING OF THE BOILER

(see fig. 3.4).

1- After the sitting position has been determined, (see fig. 3.1, 3.2) allowing for clearances as shown in section 3.1, fix paper template to the wall;

2- Drill holes for wall plate fixing "B" (B = 14 mm diam.);

3- Plumb service pipes to position "C";

4- Remove template from wall. Position hanging plate "D" and secure to wall via pre-drilled holes "B" ensuring that it is level.

Important : please ensure that the fixing method used is able to support 60 Kg.

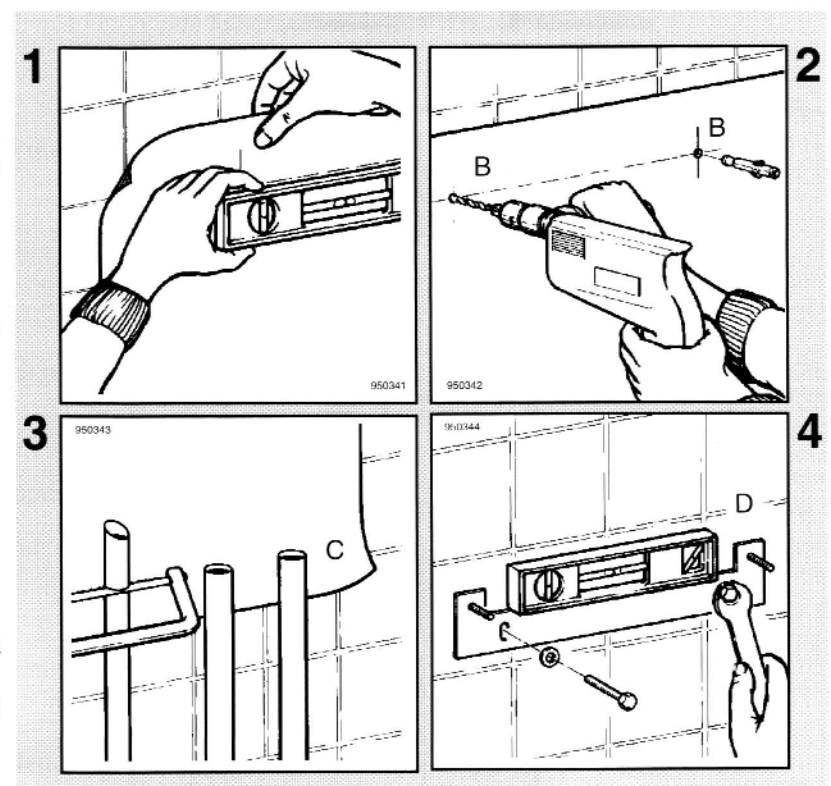

fig. 3.4

Installation

5- Mount fitting valves connections;

6- Hang the boiler on to bolts via holes in the boiler frame "F";

7- Secure boiler with nuts "G" ensuring that washers are positioned between the nut and the boiler frame.

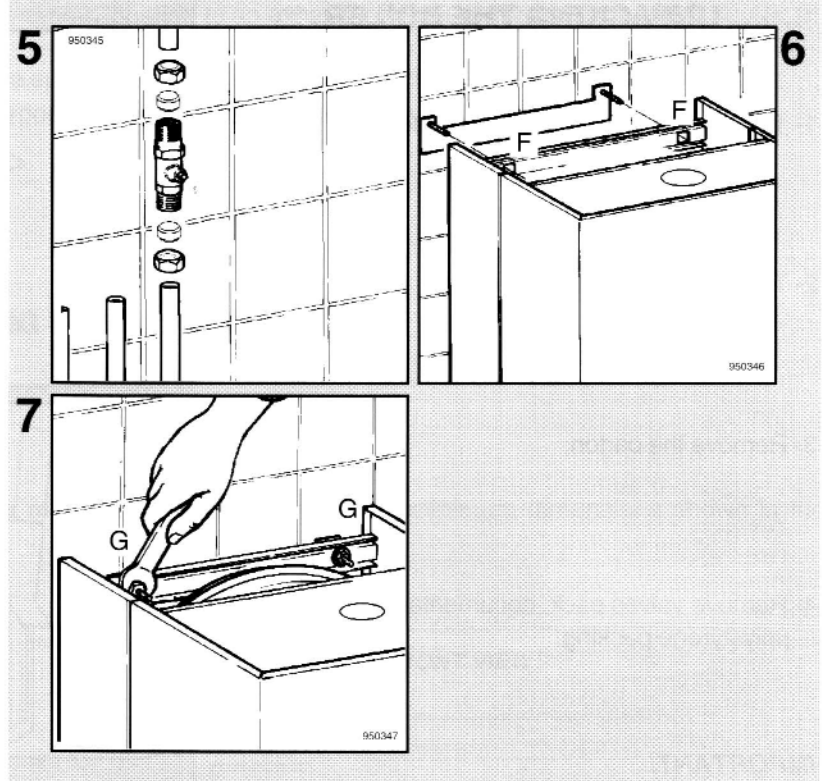

fig. 3.4

Installation

3.5 ELECTRICAL CONNECTIONS

Connecting to the electricity supply

WARNING - THIS APPLIANCE MUST BE EARTHED

The appliance is delivered with a flexible cable for electrical supply. The cable allows the electrical connection as detailed in sect. 2.8 .

Replacing the electrical supply cable

- 1 - Ensure electricity is switched off at main isolator;
- 2 - Remove boiler casing (see sect. 6.2);
- 3 - Lower control panel (see sect. 6.2);
- 4 - Remove cables from terminals by loosening screws "A" (see fig.3.10);
- 5 - Loosen screw "B" to slacken the cable holder (see fig.3.11);
- 6 - Remove the cable;
- 7 - Insert the new cable through grommet.
A PVC insulated flexible cable must be used. it must be a three core of size 0.75 mm² (24x0.2 mm) to BS6500 table 16;
- 8 - Connect the cable to the terminals marked as follows:
 - L Brown or red wire (live)
 - N Blue or black wire (neutral)
 - ⊕ Green/yellow or green wire (earth);

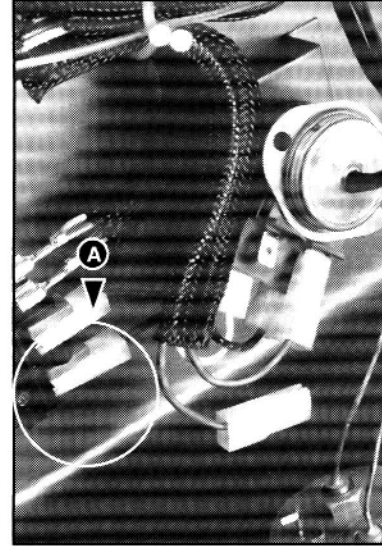

fig. 3.10

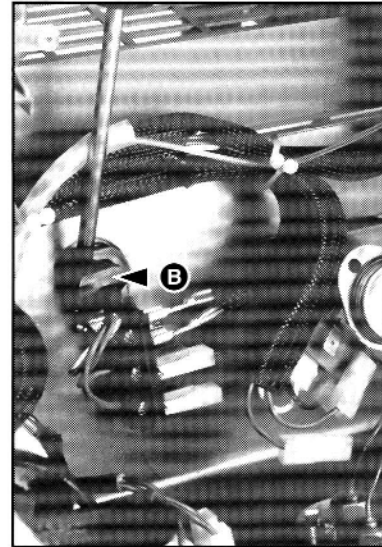

fig. 3.11

Electrical connection of a room thermostat (see fig.3.12)

Remove the green connector, placed on the left of the P.C.B.

Remove one of the two brown U-links.

Fit the wires of the room thermostat.

Fit the connector in its housing.

IMPORTANT!

The room thermostat must be of a low voltage type (i.e. no live connection).

WARNING:

A room thermostat must be used which only can be opened with a tool .

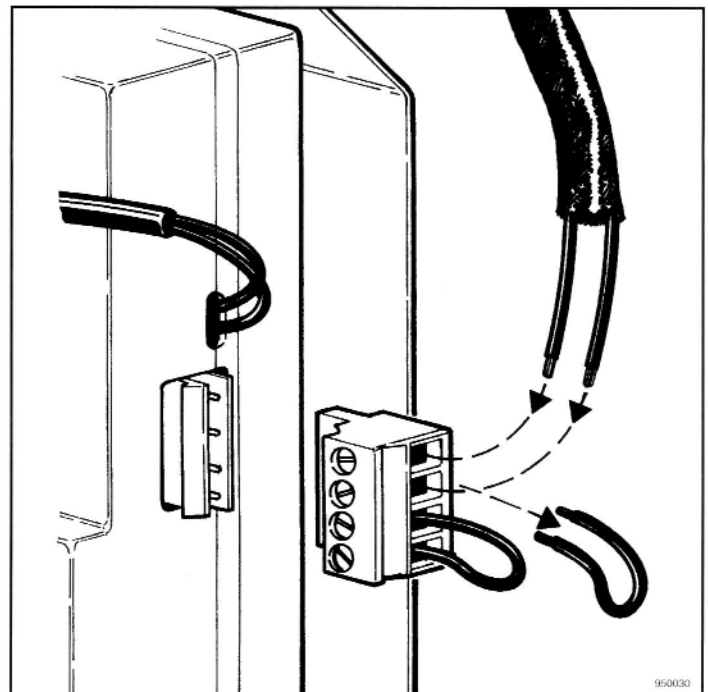

fig. 3.12

4 COMMISSIONING

4.1 ELECTRICAL INSTALLATION

Preliminary electrical system checks to ensure electrical safety must be carried out by a qualified electrician.

I.e. polarity, earth continuity, resistance to earth and short circuit. If a fault has occurred on the appliance the fault finding procedure should be followed as specified under the servicing section of this document.

4.2 GAS SUPPLY INSTALLATION

1 Inspect the entire installation including the gas meter, test for soundness and purge, as described in BS6891;

2 Open the gas cock (drawn with the knob in "open" position on the appliance) and check the gas connector on the appliance for leaks (see fig. 4.1.).

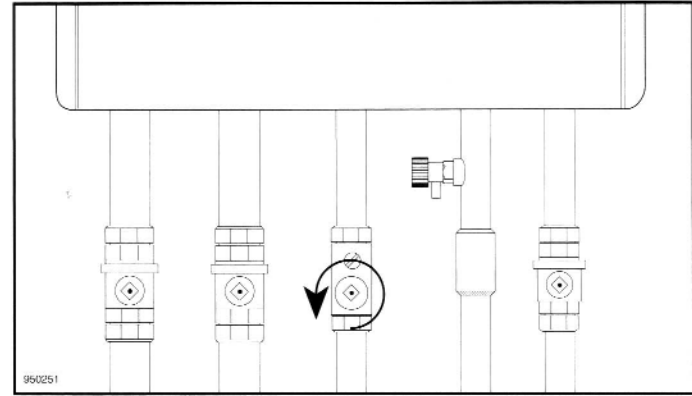

fig. 4.1

4.3 FILLING THE D.H.W. SYSTEM

1 Close all hot water draw-off taps;

2 Open the cold water inlet cock as indicated in fig. 4.2;

3 Slowly open each draw-off tap and close it only when clear water, free of bubbles, is visible.

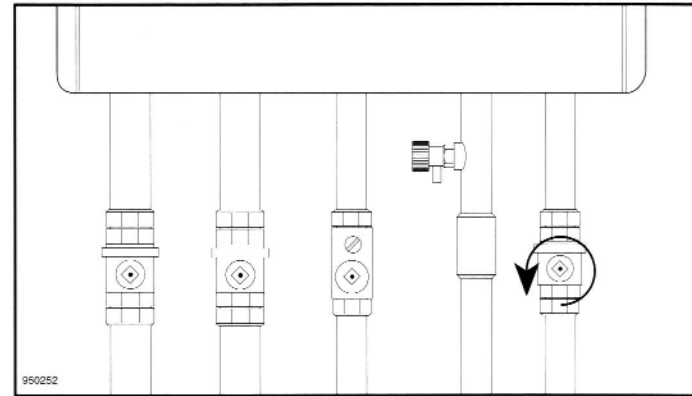

fig. 4.2

4.4 INITIAL FILLING OF THE SYSTEM

1 Open central heating flow and return cocks as indicated in fig. 4.3;

2 Unscrew the cap on the automatic air release valve one full turn and leave open permanently;

3 Close all air release valves on central heating system;

4 Gradually open stopcock at the filling point connection to central heating system until water is heard to flow; do not open fully;

5 Open each air release tap starting with the lower point and close it only when clear water, free of bubbles, is visible;

6 Remove the front panel of the case and lower the control panel (sect. 6.2);

7 Purge the air from the pump by unscrewing the pump plug indicated as indicated in fig. 4.4; release the pump by turning the rotor in the direction indicated by the arrow on the information plate;

8 Close the pump plug;

9 Continue filling the system until at least 1 bar (14.5 p.s.i.) registers on the temperature-pressure gauge;

10 Inspect the system for water soundness and remedy any leaks discovered.

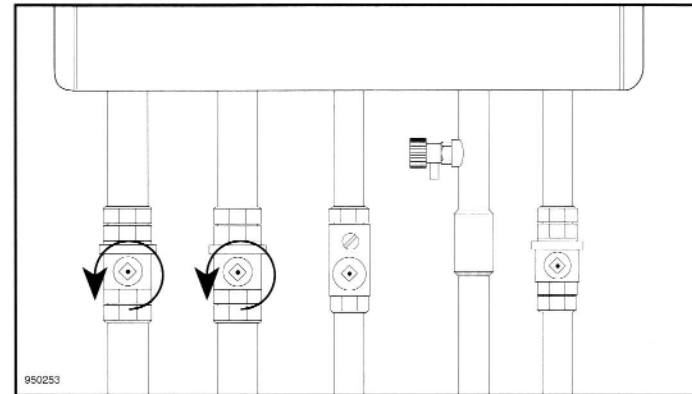

fig. 4.3

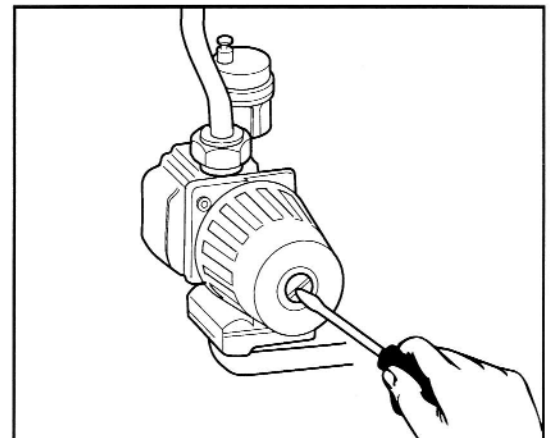

fig. 4.4

Commissioning

When the installation and filling are completed turn on the central heating system (sect. 4.5) and run it until the temperature has reached the boiler operating temperature.

The system must then be immediately flushed through. The flushing procedure must be in line with BS7593:1992 *treatment of Water in Domestic Hot Water Central Heating Systems*.

During this operation, we highly recommend the use of a central heating flushing detergent, whose function is to dissolve any foreign matter which may be in the system i.e. Fernox Superfloc or equivalent.

Substances different from these, could create serious problems to the pump or others components.

We also recommend the use of an inhibitor in the system such as Fernox MB1 Universal or equivalent

4.5 SETTING THE SYSTEM PRESSURE

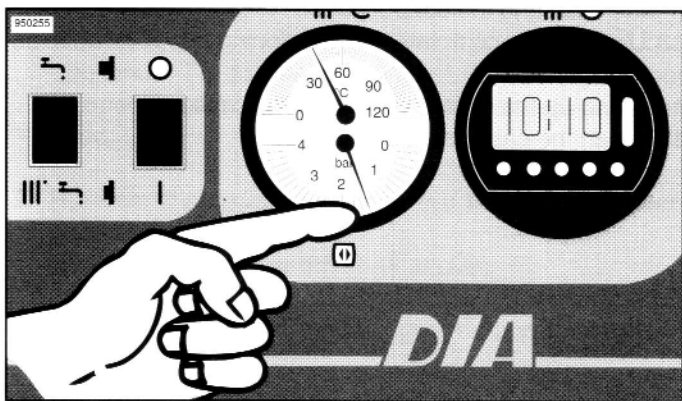

fig. 4.5

The actual reading should ideally be 1.5 bar (see fig. 4.5).

4.6 LIGHTING THE BOILER

Set the time clock to manual (1) - if fitted.

If external controls are fitted e.g. Timeclock, room thermostat ensure that they "call for heat".

1 Switch on the electricity and turn on boiler by pushing button "A", ensuring that the neon is on. (If neon does not come on then check electrical connections) (see fig. 4.6).

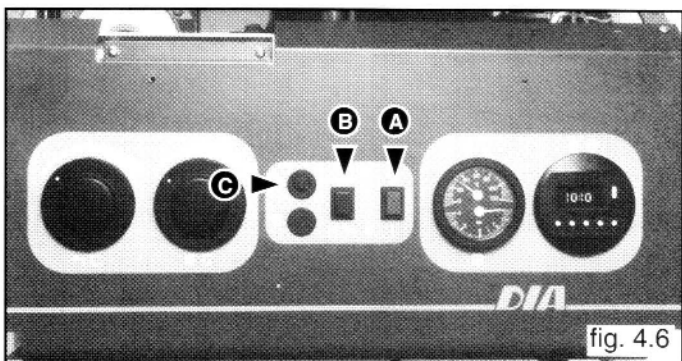

fig. 4.6

2 Select heating mode by setting button "B" to heating mode III (see fig. 4.6).

3 Check the burner pressures and adjust as necessary as in section 6.5.

The boiler will now go through an ignition sequence and the burner will light.

4.7 CHECKING THE FULL SEQUENCE CONTROL

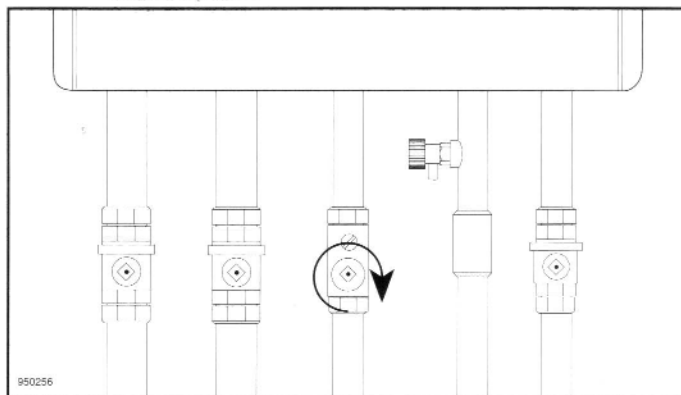

fig. 4.7

With the burner on high flame, close the gas cock (drawn with the knob in "close" position) turning the screw in a clockwise direction (see fig. 4.7);

After several seconds, the shut-down warning light will appear. To reset the boiler, open gas cock and depress the reset push button "C" marked with the symbol ⚡ (see fig. 4.6).

4.8 TESTING THE D.H.W. SYSTEM FLOW

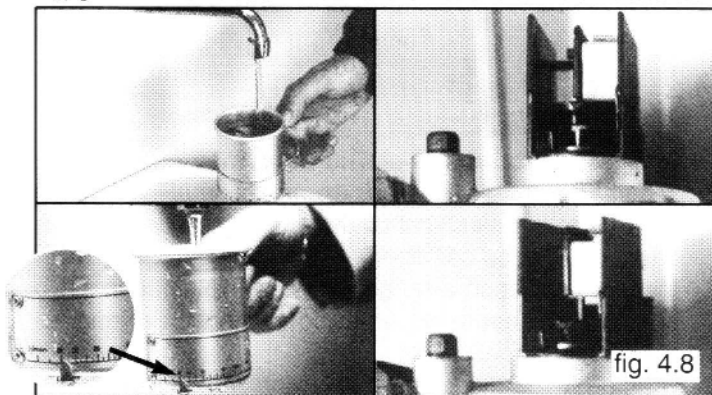

fig. 4.8

1 Turn the function switch as indicated and check the switching flow rate that should be at minimum 2.5 lts/min (0.66 gals/min); (see fig. 4.8)

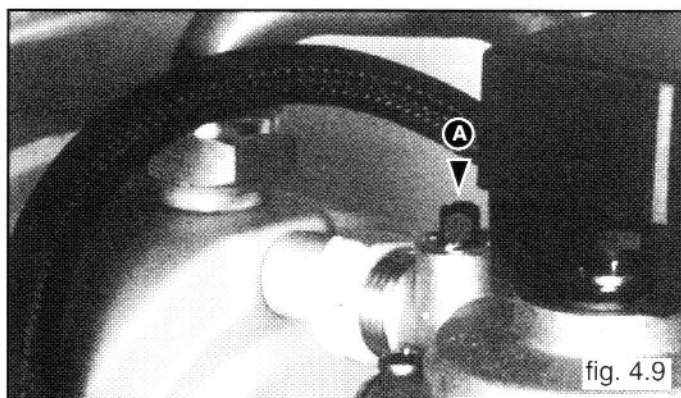

fig. 4.9

2 To set maximum flow

- Turn on the tap with maximum water flow fully (e.g. bathtub);
- Using a flow meter, set the flow on 13 lts/min (3.43 gals/min) by turning screw "A" (see fig. 4.9) for DIA 24 MI CE and 11 lts/min for DIA 20 MI CE models.

5 MAINTENANCE

5.1 GENERAL

To ensure efficient, safe operation of the appliance it is necessary to carry out routine maintenance at regular intervals.

The frequency of servicing will depend upon the particular installation conditions and the use of the boiler, but, in general, once a year should be adequate.

The following notes apply to the appliance but it should be remembered that attention must be also paid to the central heating and domestic hot water circuits with special attention to radiator valves; thermostats, clocks, leaking hot water taps etc.

WARNING

Before starting any servicing work, switch-off the electrical supply or disconnect the plug at the main isolating switch and socket (if a switch is used remove the fuse).

After any service on electrical components carry out a preliminary electrical checks; in particular:
earth continuity;
polarity;
earthing resistance;
short circuit.

5.2 RECOMMENDED ROUTINE MAINTENANCE

The following procedures should be carried out at least once a year:

- 1 Verify that the electrical connections, the flue and the case are in good condition;
- 2 Inspect ventilation arrangements as explained in section 2.5 to ensure no alterations have been made since installation;
- 3 Switch-off the electrical supply and remove the front panel of the case (section 6.2);
- 4 Switch-on the electrical supply and run the boiler for few minutes in d.h.w. mode;
- 5 Check that the flame covers all the flame ports and is of a light blue colour. Yellow flames and excessive lifting of flames indicate poor combustion.
- 6 Visually check the flue system for soundness.
Check all clamps, gaskets and fixings are secure and tight.

To inspect and clean the appliance

- 7 Switch-off the electrical supply, remove the front combustion chamber panel (section 6.2);
- 8 If during initial check any combustion irregularity is suspected, remove the burner and the injectors (section 6.13).
Clean or replace if necessary;
- 9 Inspect the main heat exchanger for any deposits of soot. If cleaning is necessary place a cloth over the burner to catch debris and clean the main heat exchanger using a soft brush.
Do not use brushes with metallic bristles;
- 10 Inspect the combustion chamber panels.
Damaged panels should be replaced;
- 11 Check sealing gaskets and replace if required;
- 12 Replace all parts in reverse order with the exception of the case and the control panel;
- 13 Undertake a complete commissioning check as detailed in section 4;
- 14 Close-up the control panel and the case;
- 15 Clean the case using a soft cloth.

6 SERVICING INSTRUCTIONS

6.1 REPLACEMENT OF PARTS

The life of individual components varies and they will need servicing as and when faults develop.

The fault finding sequence chart in chapter 7 will serve to locate which component is the cause of any malfunction, and instructions for removal, inspection and replacement of the individual parts are given in the following pages.

6.2 TO GAIN GENERAL ACCESS

All testing and maintenance operations on the boiler require the control panel to be lowered. These operations before require the removal of the casing.

The casing is fixed to the boiler frame by 4 screws (see fig. 6.1):

- 1- Remove 2 screws located at the bottom of the appliance. To do this we suggest that the case door is open and a long pozi-drive n°2 screw driver is used;
- 2- Remove 2 screws located on the front of the boiler, under the case door. Use the same screw driver as above;
- 3- Remove the case by pulling upwards and forwards;
- 4- Remove 2 screws at the top of control panel using a pozi-drive n°2 screw driver.

If necessary opening combustion chamber as well, continue as shown on fig. 6.3.

Opening combustion chamber

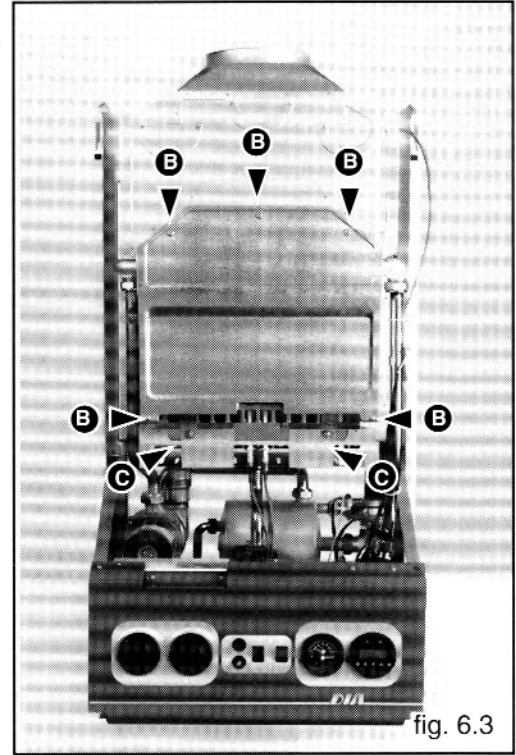

fig. 6.3

- 1 Remove screws B;
- 2 Remove screws C;
- 3 Pull forward and remove.

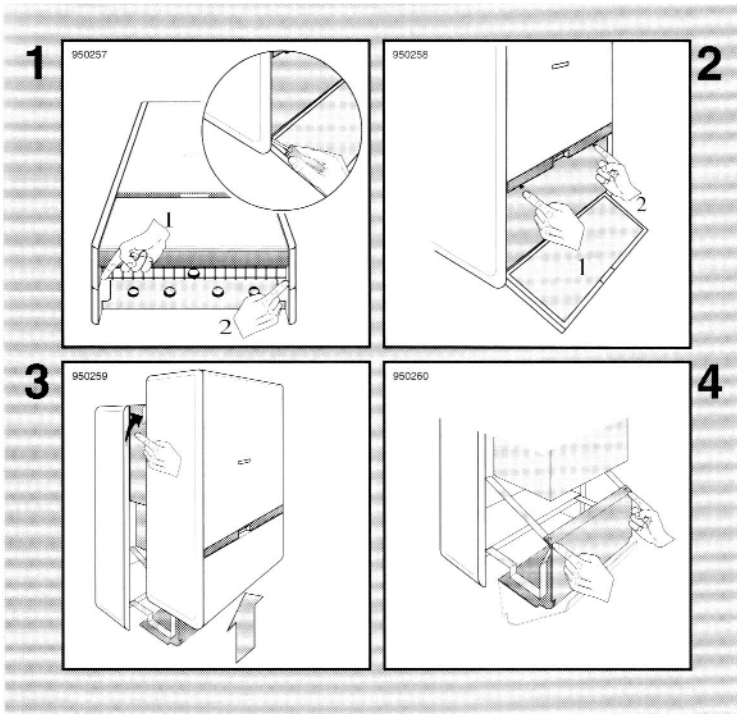
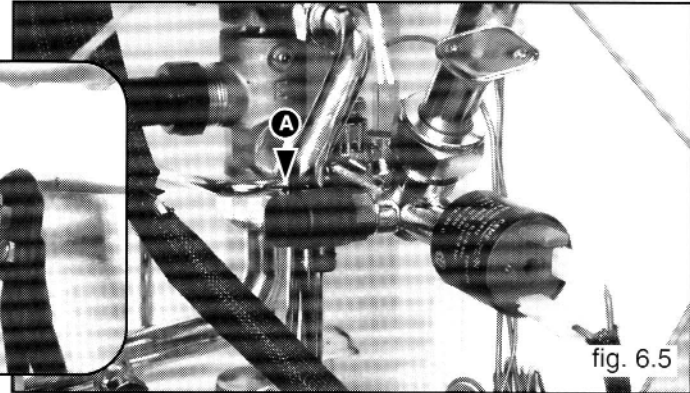
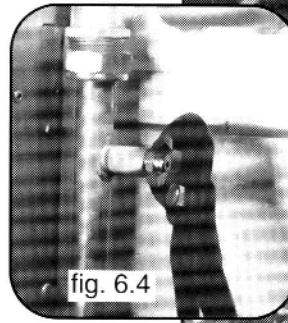

fig. 6.1

Servicing instructions

6.3 TO DRAIN THE MAIN CIRCUIT OF THE BOILER

- 1 Close c.h. flow and return cocks;
- 2 Release the manual vent cock (see fig.6.4);
- 3 Attach a small hose to the drainage cock "A" (see fig.6.5);
- 4 Open cock "A" and drain water from boiler.



6.4 TO DRAIN THE D.H.W. CIRCUIT OF THE BOILER

- 1 Close the cold water inlet cock;
- 2 Open the d.h.w. circuit drainage.

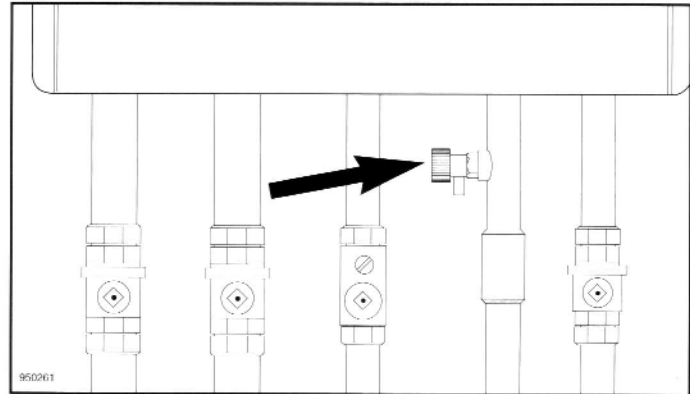

6.5 SETTING GAS PRESSURES

Setting the minimum and the maximum power of the boiler (see fig.6.8)

- 1) Check the special link (inside the P.C.B.) is correctly fitted in relation to the gas that is using (see fig.1).
- 2) Check that the supply pressure of gas valve is 20 mbar for natural gas.
- 3) To do this, remove the screw "B". Fit the pipe of the pressure gauge to the pressure connection of the gas valve. When you have completed this operation, fit the screw "B" securely into its housing to seal off the gas.
- 4) To check the pressure supplied by the gas valve, remove the screw "A". Fit the pipe of the pressure gauge to the pressure outlet of the gas valve.
- 5) Set the ON/OFF switch to position <I> and the "summer/winter" switch to winter position III' 2. To set the maximum power, turn on the hot water tap and allow hot water tap to run at a rate of about 8 litres/minute so that the main burner lights. Adjust screw "D" on the solenoid to set the pressure valve (displayed on the pressure gauge) corresponding to the maximum power (see table sect.1.2).

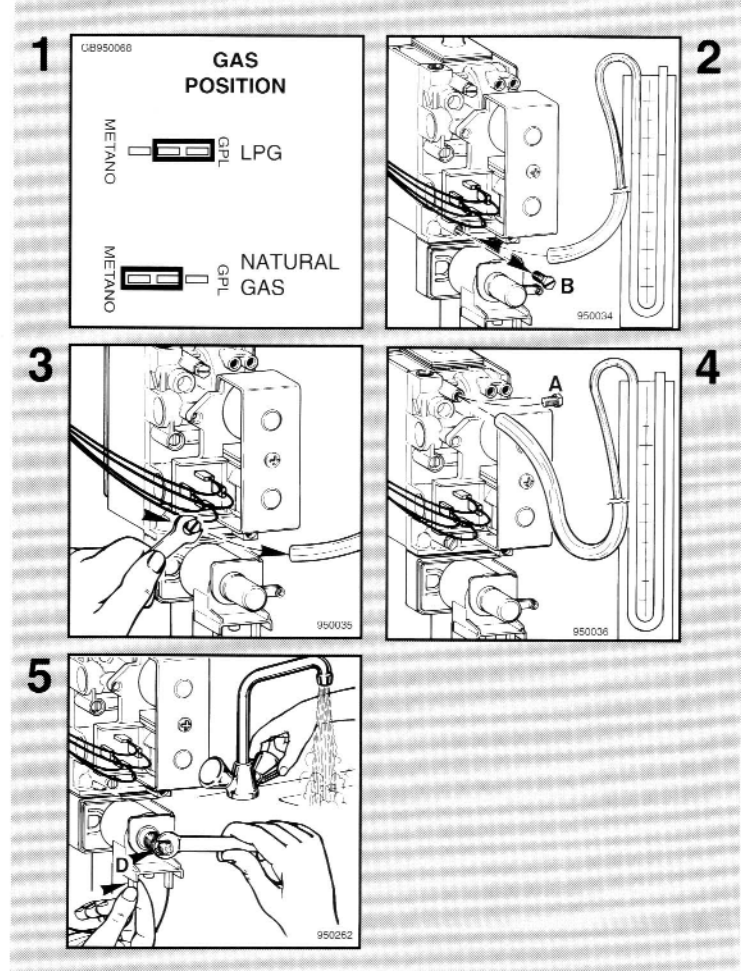

Servicing instructions

- 7) To set the minimum power, disconnect a supply terminal and adjust screw "C".
Turn the screw clockwise to increase the pressure and counter-clockwise to decrease the pressure (displayed on the pressure gauge) corresponding to the minimum power (see table sect.1.2).
- 8) When you have completed the above operations, turn off the hot water tap, re-connect the supply terminal to the solenoid on the gas valve and replace the cap on the screw of the solenoid.

Setting the maximum heating circuit power (see fig. 6.9)

- 1) To set the maximum heating circuit power, place the ON/OFF switch to position <I> and the "summer/winter" switch to winter position III. Turn the knob of the heating thermostat clockwise to maximum;
- 2) Lower control panel and find PCB on its internal left side. Remove the transparent cover and fit a cross-head screw driver in to the left side potentiometer. Turn clockwise to increase the pressure or counter-clockwise to reduce the pressure. Adjust the setting to the required heating pressure value (displayed on the pressure gauge), as indicated in the diagrams shown at the end of this manual.
- 3) Turn off the boiler by placing the main switch on "OFF" position.
Disconnect the detection electrode cable.
Turn on the boiler by placing the main switch to position "I" and sparks will come on.
Check the gas pressure on the pressure gauge which must be about 5 mbar .

RECOMMENDED PRESSURE FOR SLOW IGNITION

NATURAL GAS (G20)	BUTANE GAS (G30)	PROPANE GAS (G31)
5 mbar 1.95 in w.g.	18 mbar 7.0 in w.g.	19 mbar 7.4 in w.g.

If it is necessary adjust the slow ignition.

Fit a cross-head screw driver into the hole marked "REGULATION OF SLOW BURNER IGNITION" on the electronic P.C.B., through the potentiometer.

- 4) Remove the pipe of the pressure gauge and connect screw "A" to the pressure outlet in order to seal off the gas.
- 5) Carefully check the pressure outlets for gas leaks (valve inlet and outlet).

IMPORTANT!

Whenever you disassemble and reassemble the gas connections, always check for leaks using a soap and water solution.

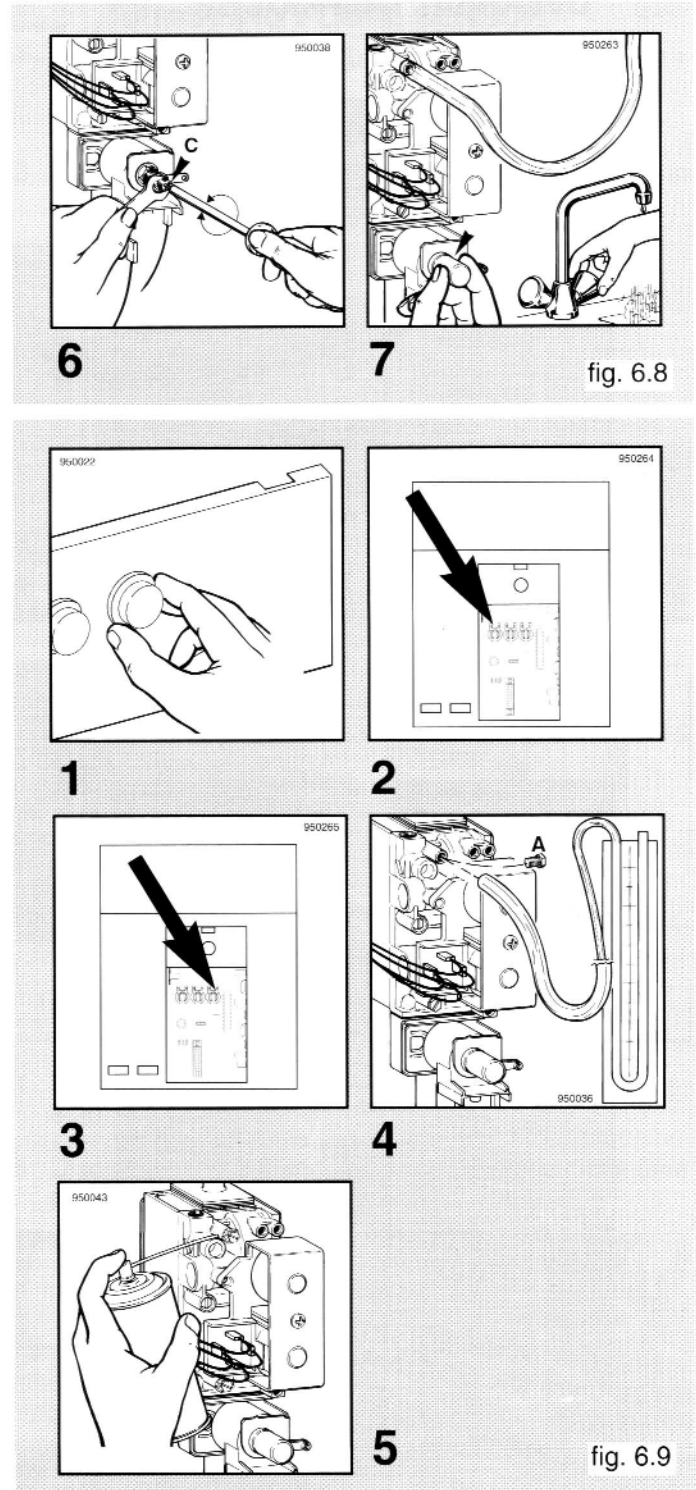

fig. 6.8

fig. 6.9

Setting the delay of the ignition of the heating control

This appliance is equipped with a potentiometer which delays the ignition of the heating control and is situated on the P.C.B. (see electric diagrams).

By adjusting the potentiometer, it is possible to change the time interval between the burner shutting down and its next ignition.

It is preset at 1 minute and can be adjusted from 0 to 2 minutes.

We could need this control in particular situations with continuous shutting down and ignitions of the main burner.

6.6 OVERHEAT THERMOSTAT

1 Ensure electricity is switched off at main isolator;

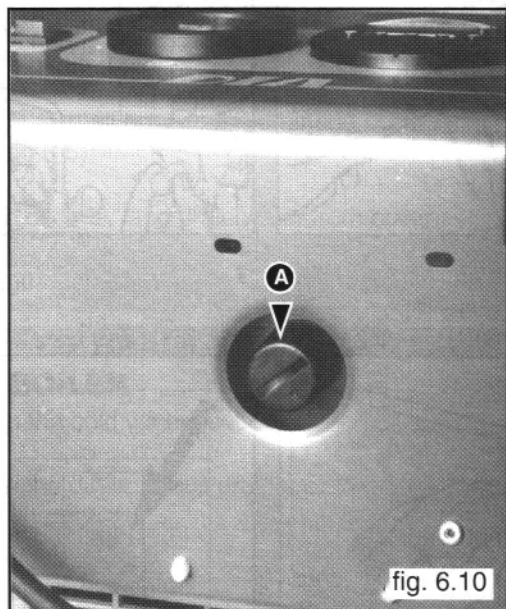

2 Remove cap "A" (see fig. 6.10);



3 Remove the securing nut "B" (see fig. 6.11);

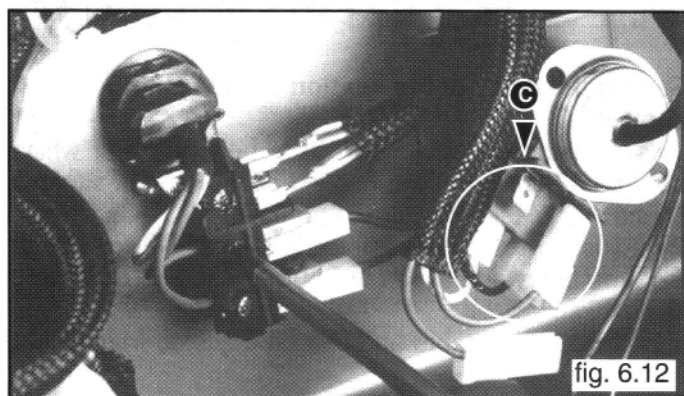

4 Lower control panel (sect. 6.2) and remove electrical connectors "C" (see fig. 6.12);

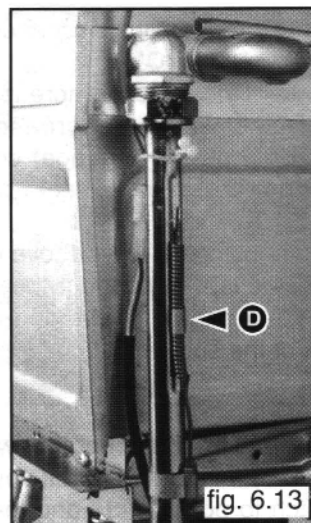

5 Remove spring "D" (see fig. 6.13).

6 Reassemble in reverse order.

6.7 REMOVING IGNITION ELECTRODES

1 Ensure electricity is switched off at main isolator;

2 Lower control panel (sect. 6.2);

3 Disconnect cables pulling them downwards (sect. 6.15);

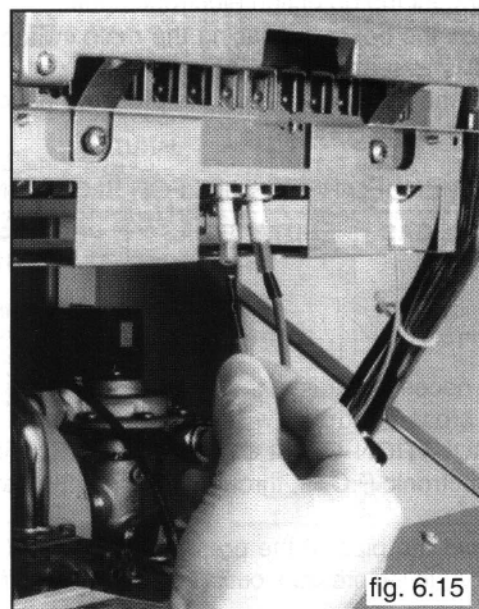

Servicing instructions

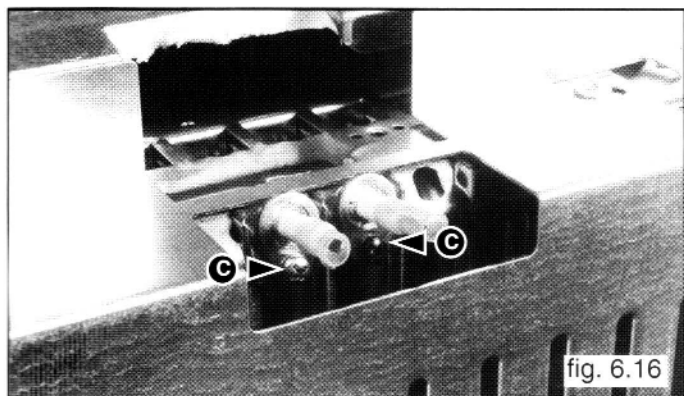

5 Remove screws "C" using a PHILLIPS No.2 star tip screw-driver (see fig. 6.16);

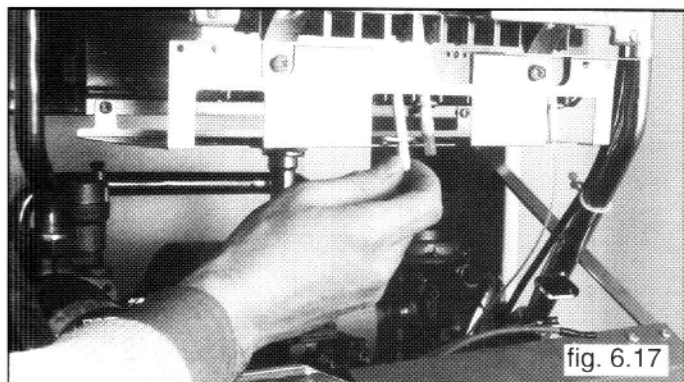

6 Slide the electrodes gently downwards (see fig. 6.17);

To mount, repeat the steps in reverse order, paying particular attention to the following:

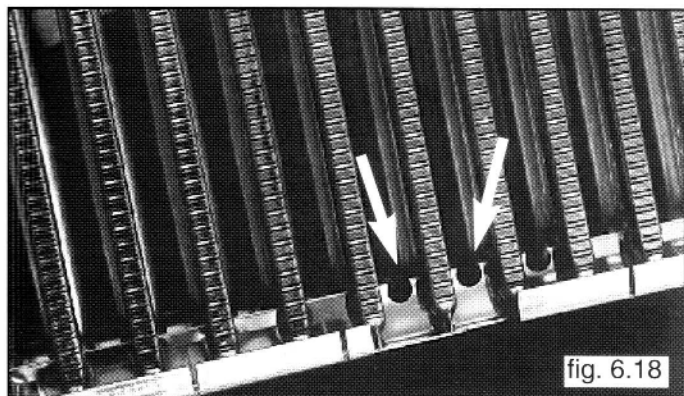

a Centre the second support hole which you will find between the connections, otherwise the electrode may break (see fig. 6.18);

6.8 REMOVING FLAME SENSOR

- 1 Ensure electricity is switched off at main isolator;
- 2 Lower control panel (sect. 6.2);
- 3 Remove the screw using a PHILLIPS No.2 star tip screw-driver (see fig. 6.20);

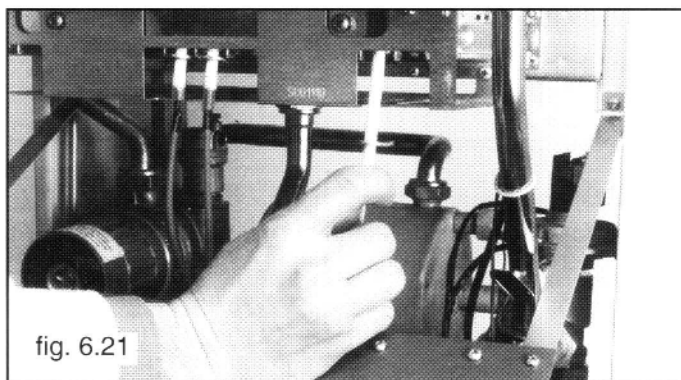
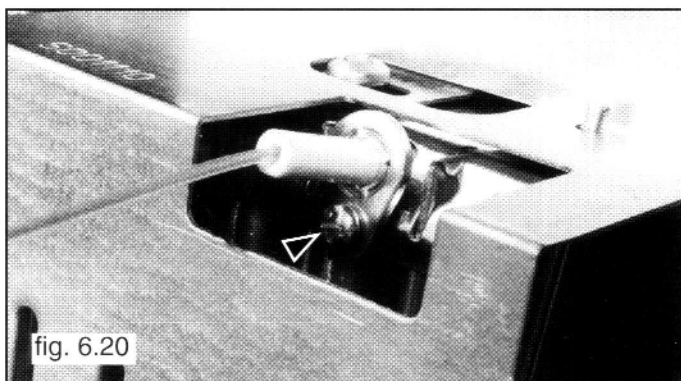

4 Slide the electrode downwards very gently (see fig. 6.20);

5 Disconnect the cable at its only connection point (see fig. 6.22);

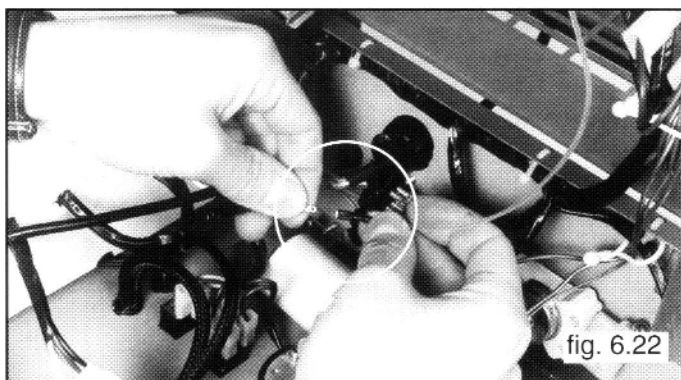

When you reassemble the part, follow the steps in reverse order ensuring that you centre the second support hole between the connection, otherwise the electrode may break.

Servicing instructions

6.9 REMOVING D.H.W. AND C.H.W. POTENTIOMETERS

Both potentiometers are mentioned because they are connected together.

It is not possible to remove only one potentiometer!!

1 Ensure electricity is switched off at main isolator;

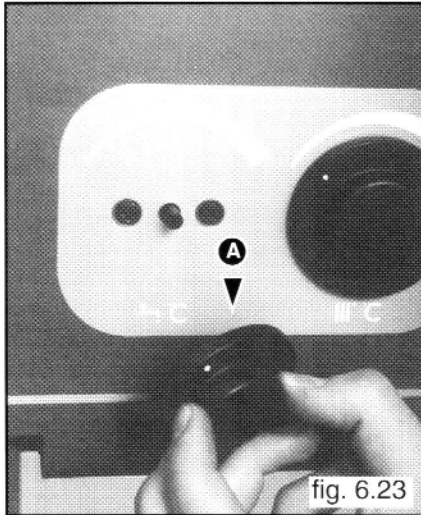

fig. 6.23

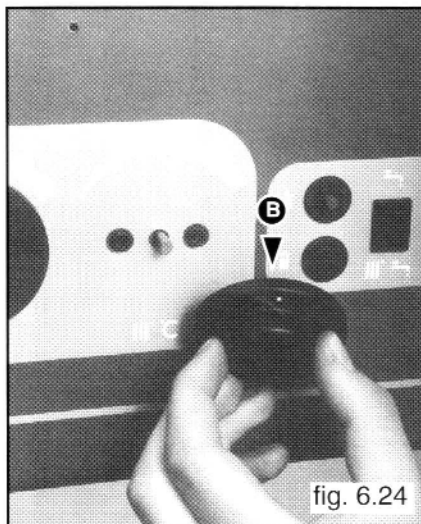

fig. 6.24

2 Remove knobs "A" (see fig. 6.23) and "B" (see fig. 6.24);

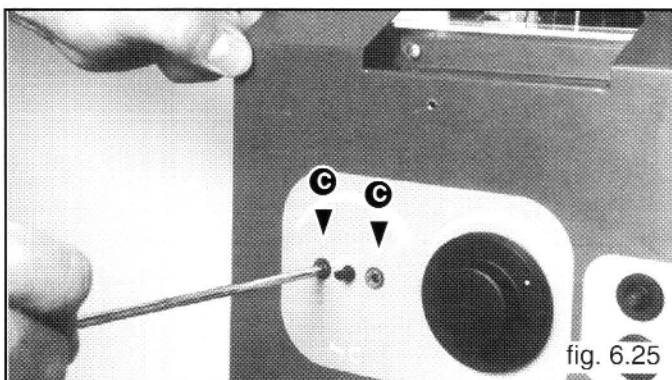

fig. 6.25

3 Remove screws "C" using a Phillips n°2 star tip screw driver (only two visible). (see fig. 6.25);

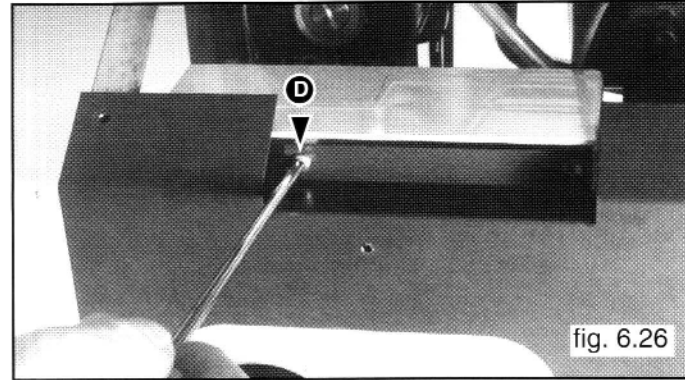

fig. 6.26

4 Remove screws "D" using a Pozi-drive n°2 star trip screw driver (one is visible). (see fig. 6.26);

5 Lower control panel;

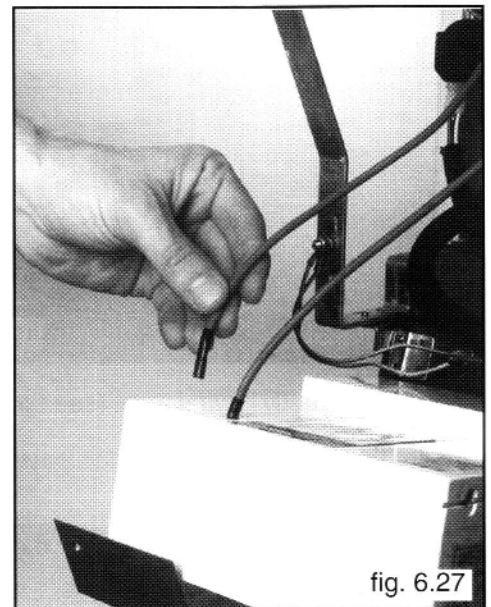

fig. 6.27

6 Disconnect special cables for ignition electrodes (see fig. 6.27);

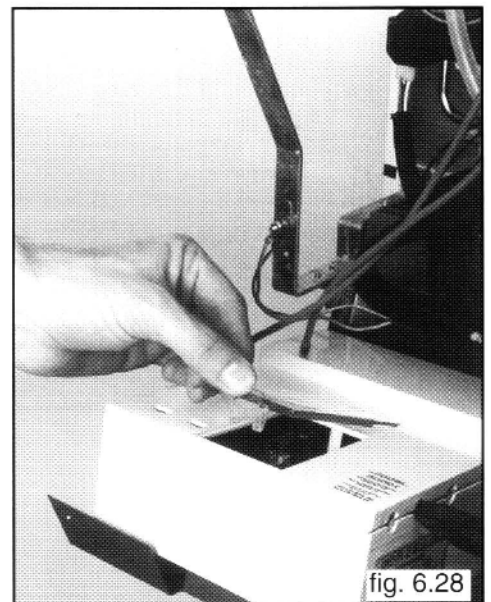

fig. 6.28

7 Remove the small transparent cover by pushing on the front side (see fig. 6.28);

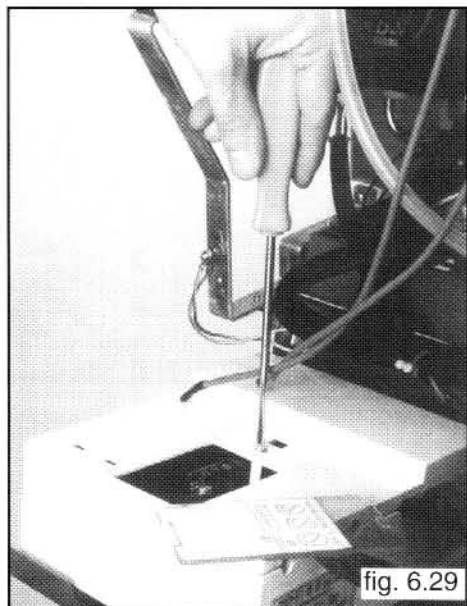

fig. 6.29

8 Open the P.C.B. box removing the not visible screw "E". To this end use a Phillips n°2 star trip screw driver (see fig. 6.29);

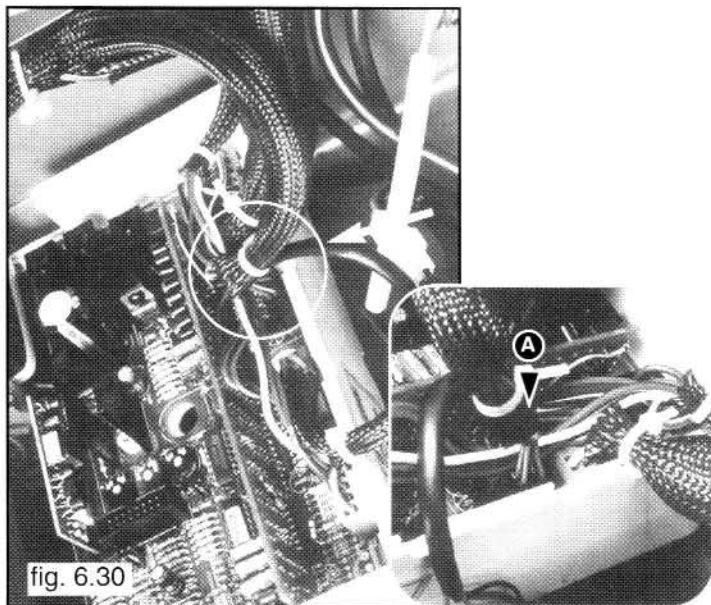

fig. 6.30

9 Remove connector "K" (see fig. 6.30);

10 Remove both potentiometers lifting the P.C.B. box slowly at the front side;

11 Reassemble in reverse order.

6.10 REMOVING D.H.W. SENSOR PROBE

1 Ensure electricity is switched off at main isolator.

2 Lower control panel (sect. 6.2);

3 Drain Dhw circuit (sect. 6.4);

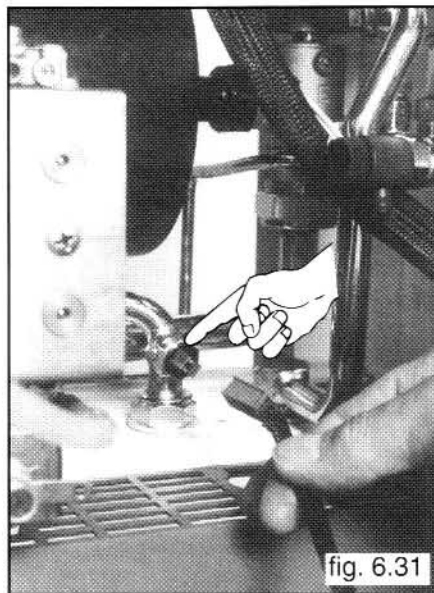

fig. 6.31

4 Disconnect the electric connector by pulling back (see fig. 6.31);

5 Unscrew the sensor probe using a 14 mm open ended;

6 Reassemble in reverse order.

6.11 REMOVING C.H.W. SENSOR PROBE

1 Ensure electricity is switched off at main isolator.

2 Lower control panel (sect. 6.2);

3 Drain boiler (sect. 6.3);

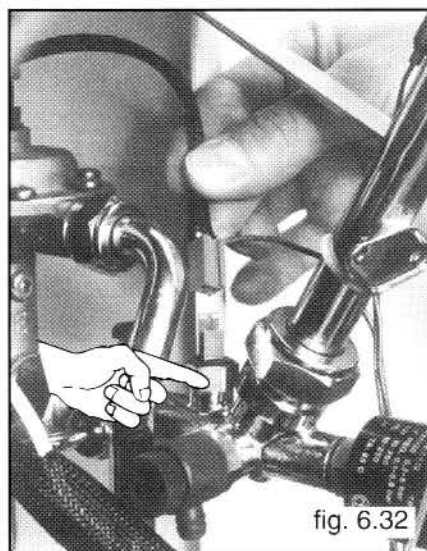

fig. 6.32

4 Disconnect the electric connector by pulling up (see fig. 6.32);

5 Unscrew the sensor probe using a 14 mm open ended;

6 Reassemble in reverse order.

Servicing instructions

6.12 MICROSWITCHES ON DIVERTOR VALVE

- 1 Ensure electricity is switched off at main isolator;
- 2 Lower control panel (sect. 6.2);

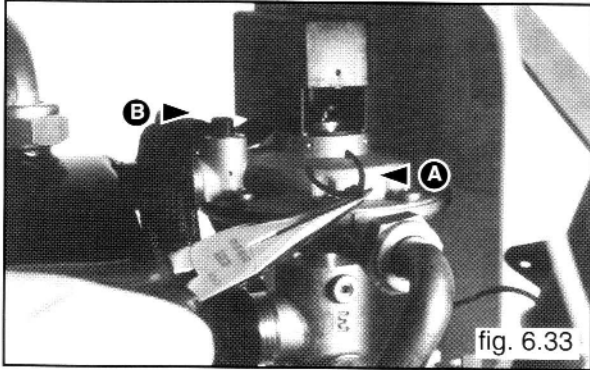

- 3 Remove retention clip A (see fig. 6.33);
- 4 Lift box B and remove from valve (see fig. 6.33);

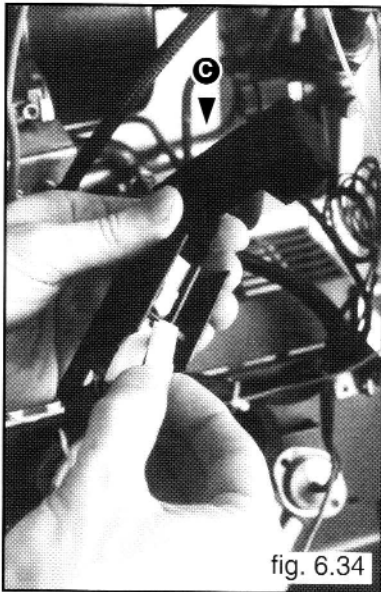

- 5 Remove cover C if fitted (see fig. 6.34);
- 6 When disconnecting electrical connection, mark in reference points to help you reassemble the part without problems;
- 7 Reassemble in reverse order.

6.13 BURNER and INJECTORS

- 1 Ensure electricity is switched off at main isolator;
- 2 Lower control panel (sect. 6.2);
- 3 Remove all electrodes (sect. 6.7 and 6.8);
- 4 Remove the metal grid by unscrewing n°2 bottom fixing screws. (see fig. 6.35). Use a phillips n°2 star tip screw-driver.

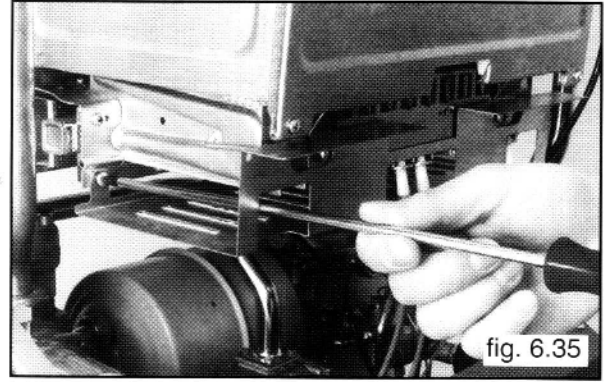

- 5 Remove n°2 frontal fixing screws. Using a phillips n°3 star tip screw-driver. (see fig. 6.36).

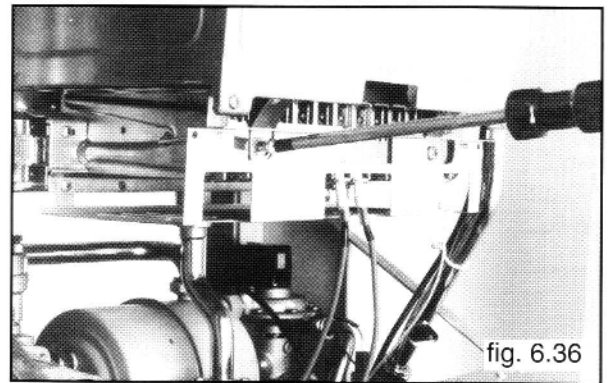

- 6 Remove two remaining screws. (see fig. 6.37) by one hand and hang the burner by the other one.

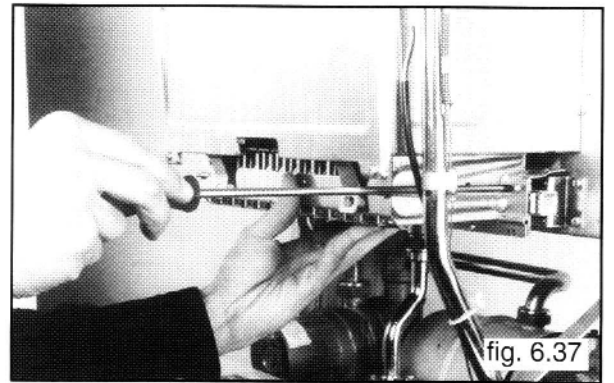

- 7 If necessary, remove the injectors using a n°7 socket spanner. Keep the washers. (see fig. 6.38). Reassemble in reverse order.

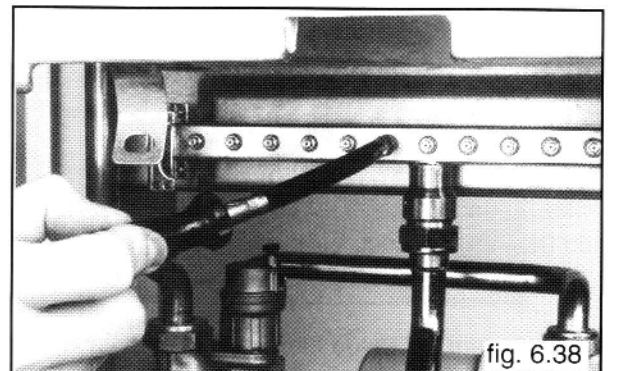

Servicing instructions

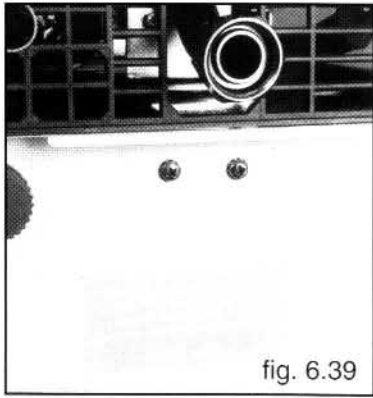

NOTE: When you are replacing the nozzles to convert the appliance for use with a different type of gas, remember to replace the existing data plate (at the bottom of the frame) with the plate supplied in the modification kit (see fig. 6.39).

6.14 INSULATION PANELS

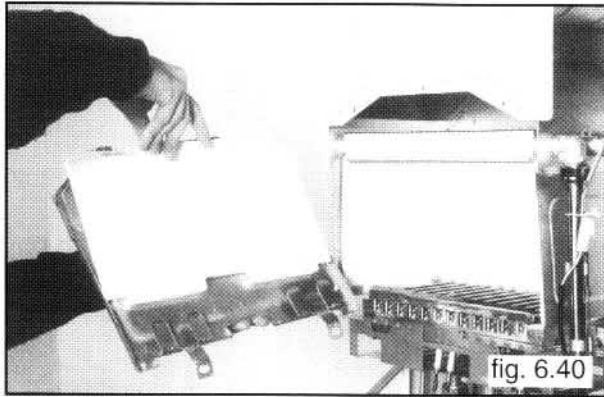

To replace the front insulation panel (see fig. 6.40)

- 1 Remove the combustion chamber panel (sect. 6.2), hold the panel firmly and pull upwards. No other tool is required.

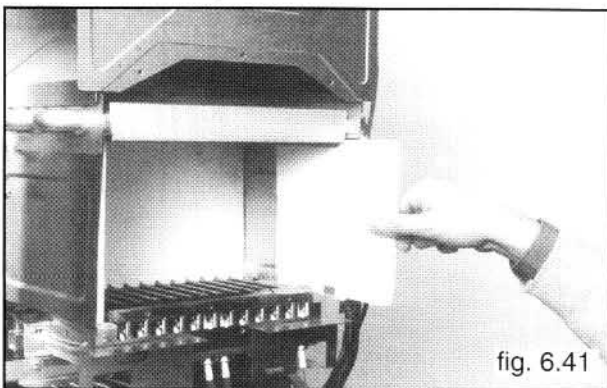

To replace the side insulation panel (see fig. 6.41)

- 1 Remove the combustion chamber panel (sect. 6.2);
- 2 Slide the side insulation panels forward;
- 3 Replace in reverse order.

To replace the back insulation panel

- 1 Remove the combustion chamber panel (sect. 6.2);
- 2 Dismount the flue hood (sect. 6.19);
- 3 Dismount the primary exchanger (sect. 6.21);
- 4 Pull the panel up and slide it out;
- 5 Reassemble in reverse order.

6.15 GAS MODULATOR CARTRIDGE

- 1 Ensure electricity is switched off at main isolator;
- 2 Lower control panel (sect. 6.2);

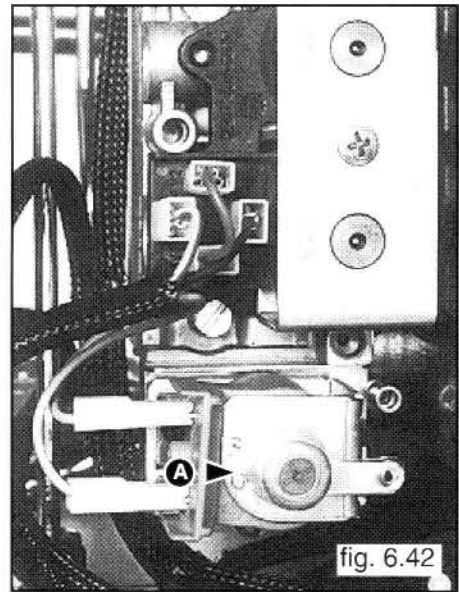

- 3 Turn the protection cap "A" and remove it from the adjustment control. Use a flat-edge screw driver to help removal (see fig. 6.42);

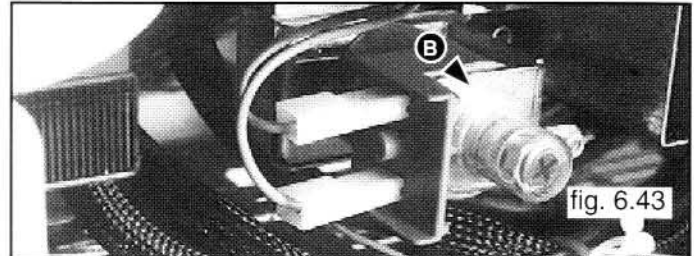

- 4 With a 14 mm spanner turn the cartridge "B" counter-clockwise (see fig. 6.43);

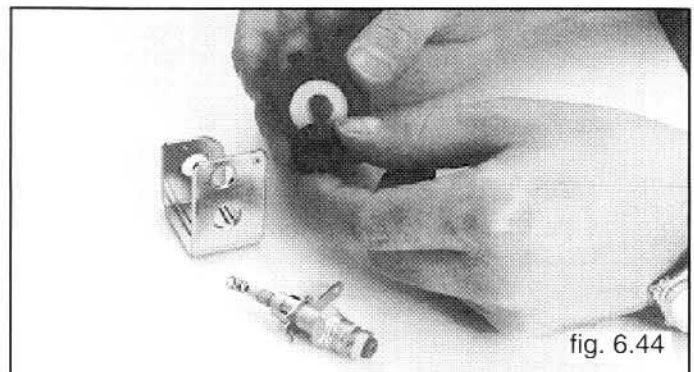

- 5 Remove the cartridge, but be very careful to not loose the internal components (see fig. 6.44);
- 6 Reassemble in reverse order.

Servicing instructions

6.16 GAS MODULATOR COIL

- 1 Ensure electricity is switched off at main isolator;
- 2 Disconnect the two cables;
- 3 Lower the control panel (sect. 6.2);
- 4 Remove the gas modulator cartridge as explained in sect. 6.16;

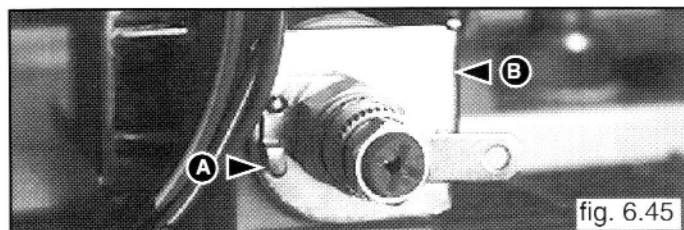

5 Slide the coil "A" and its housing from the valve (see fig. 6.45);

- 6 Remove the plate "B" (see fig. 6.45);

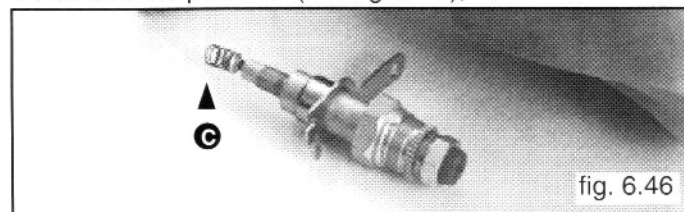

7 Slide the coil from its housing, being very careful not to lose spring "C" on the cartridge (see fig. 6.46);

- 8 Reassemble in reverse order.

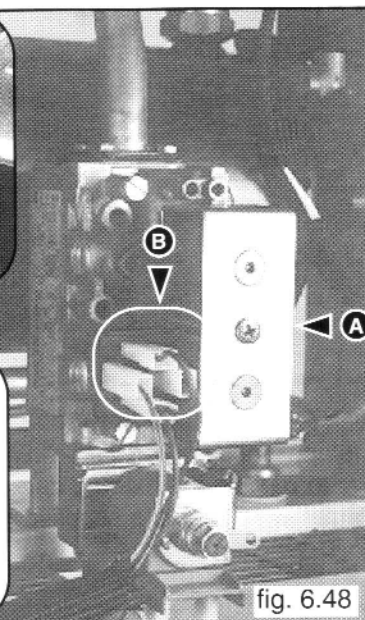
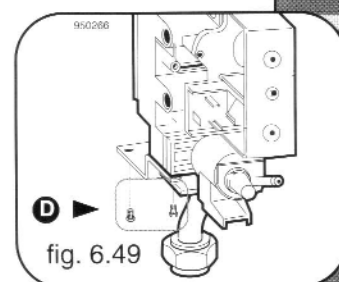
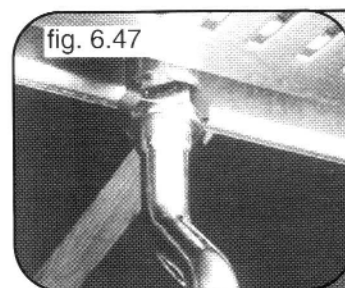

6.19 MAIN HEAT EXCHANGER

- 1 Ensure electricity is switched off at main isolator;
- 2 Drain boiler;
- 3 Remove combustion chamber front panel (sect. 6.2);
- 4 Release nuts "c" (see fig.6.55);
- 5 Pull the main exchanger straight out (see fig.6.55);

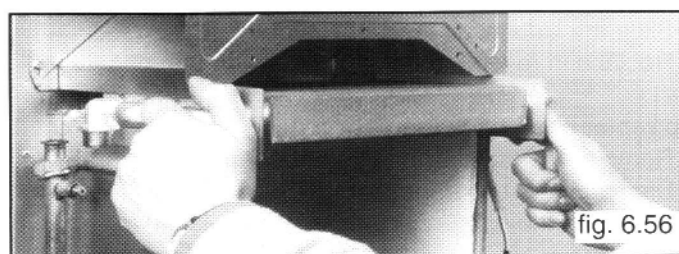
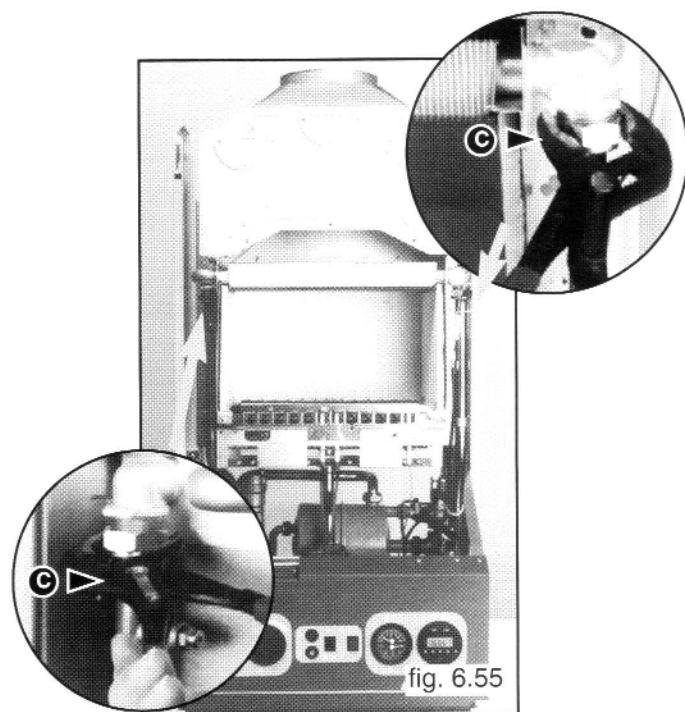

Reassemble in reverse order.

6.17 ON-OFF OPERATOR COILS

- 1 Ensure electricity is switched off at main isolator;
- 2 Lower the control panel (sect. 6.2);

To remove the TANDEM operator coil

- 3 Disconnect the cables "B" (see fig. 6.48);
- 4 Unscrew the screw "A" and slide the TANDEM coils with its housing from the valve (see fig. 6.48);
- 5 Reassemble in reverse order.

6.18 GAS VALVE

- 1 Ensure electricity is switched off at main isolator;
- 2 Remove the cover and lower control panel (sect. 6.2);
- 3 Disconnect all the cables "B" (see fig. 6.48);
- 4 Remove the bottom plastic grid.
- 5 Remove the two screws "D" (see fig. 6.49) by a Pozidrive n°2 star trip screw driver;
- 6 Release the top nut "C" using a 30 mm open ended spanner (see fig. 6.47);
- 7 Reassemble in reverse order.

Servicing instructions

6.20 FLUE CONTROL PROBE

- 1 Ensure electricity is switched off at main isolator;
- 2 Unloose screw "A" (see fig. 6.57) ;

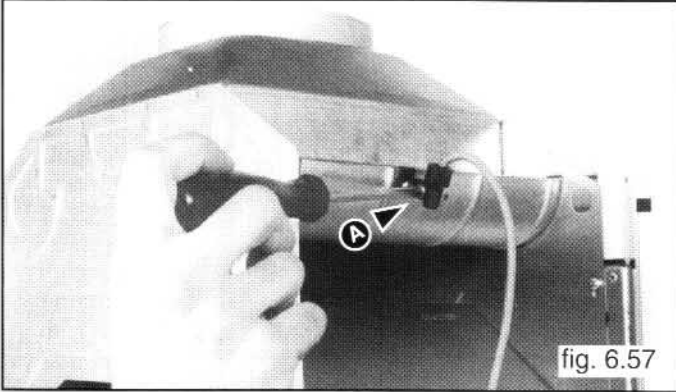

- 3 Open the cable clammer and disconnect as shown on fig. 6.58;

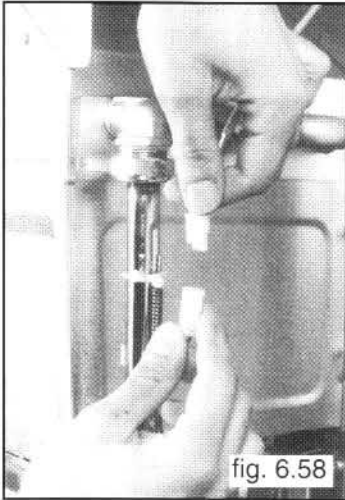

- 4 Reassemble in reverse order.

6.21 AUTOMATIC AIR PURGER

- 1 Ensure electricity is switched off at main isolator;
- 2 Drain boiler (sect. 6.3);
- 3 Unscrew valve "A" (see fig. 6.59);
- 4 Reassemble in reverse order.



6.22 PUMP

- 1 Ensure electricity is switched off at main isolator;
- 2 Drain boiler (sect. 6.3);

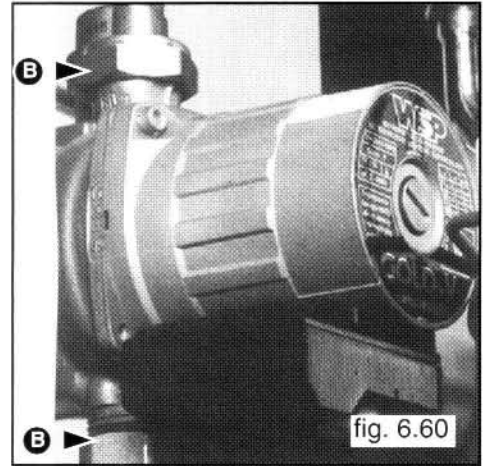

- 3 Release nuts "B" using a 36 mm open ended (see fig. 6.60);
- 4 Disconnect electrical connections (see fig. 6.61, 6.62, 6.63).

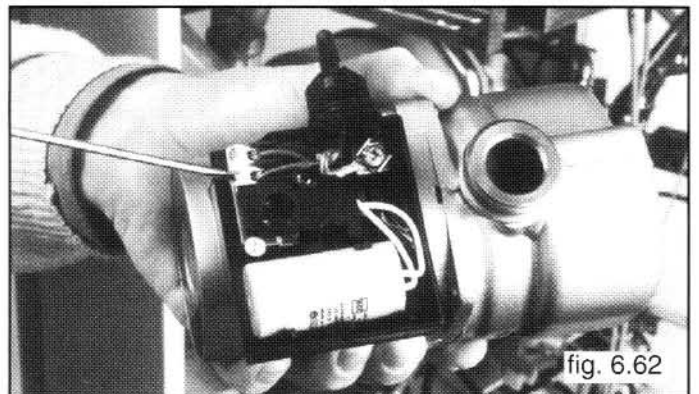
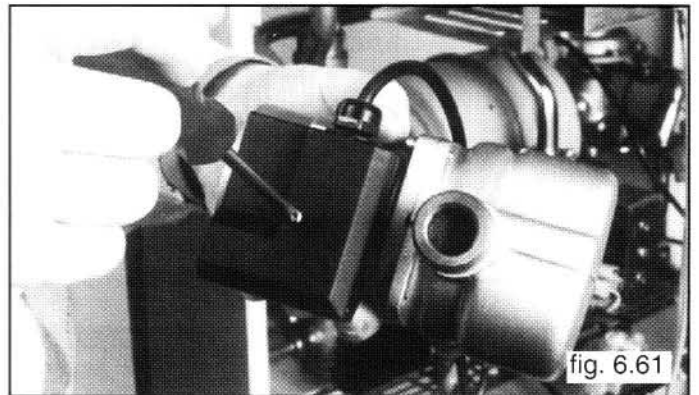

Servicing instructions

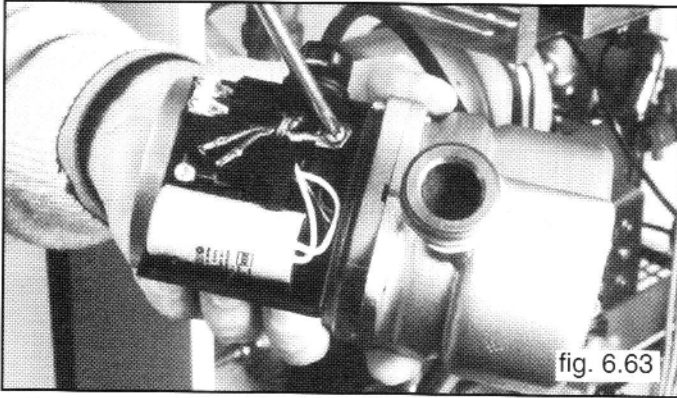

5 Reassemble in reverse order.

6.23 PUMP PRESSURE SWITCH

1 Ensure electricity is switched off at main isolator;

2 Drain boiler (sect. 6.3);

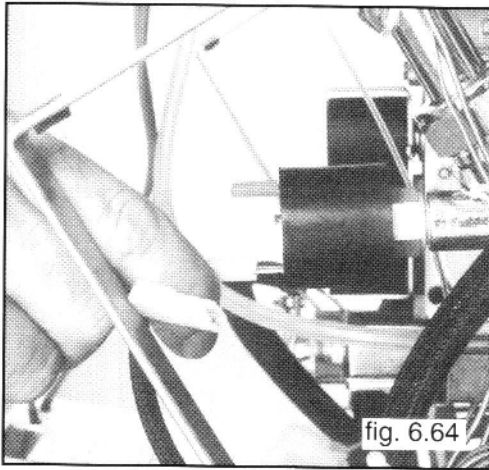

3 Disconnect electrical wires (see fig. 6.64);

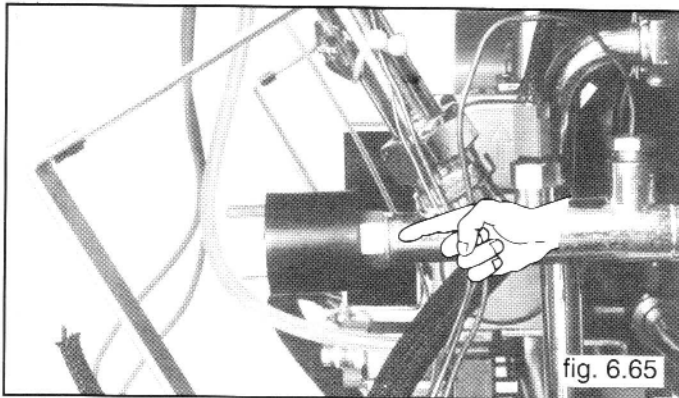

4 Remove pump pressure switch using a 17mm open ended (see fig.6.65);

5 Reassemble in reverse order.

6.24 TEMPERATURE PRESSURE GAUGE

1 Ensure electricity is switched off at main isolator;

2 Remove the cover and lower the control panel (sect. 6.2);

3 Drain boiler (sect. 6.3);

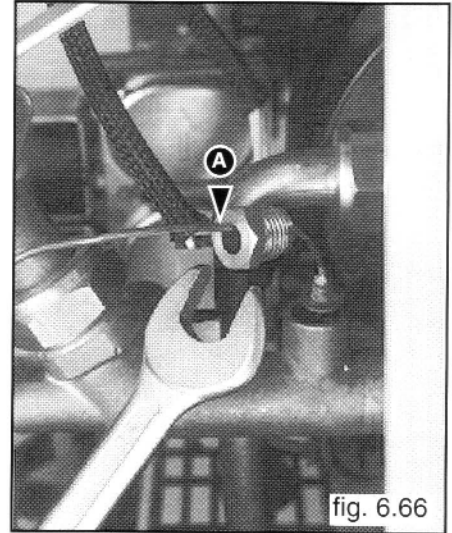

4 Release coupling "A" using a 14 mm open ended (see fig.6.66);

5 Remove the clamps joining the capillary to the electric cables;

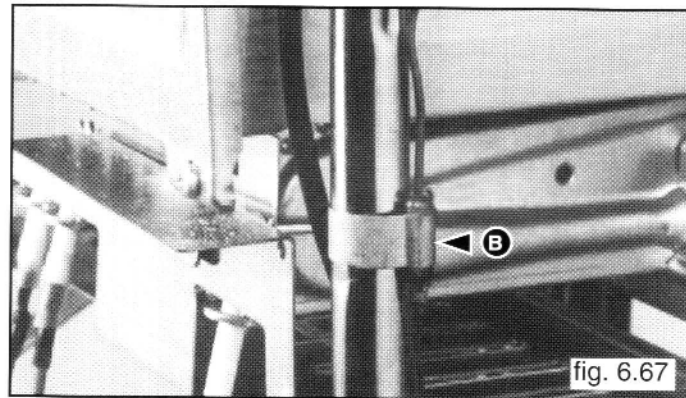

6 Remove spring "B" (see fig.6.67);

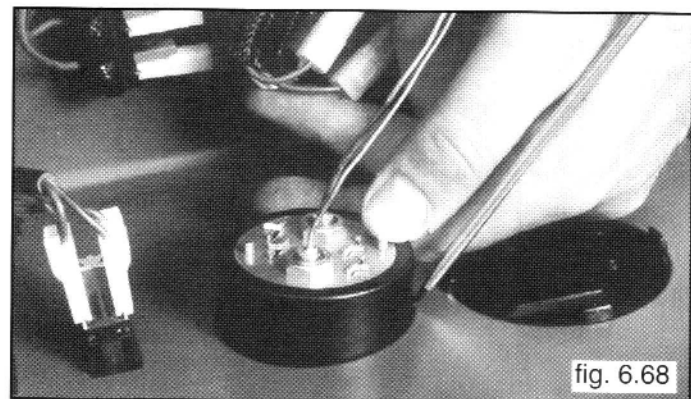

7 Push on the instrument from the interior to the exterior (see fig. 6.68);

8 Reassemble in reverse order.

Servicing instructions

6.25 REMOVING DIVERTOR VALVE

- 1 Ensure electricity is switched off at main isolator;
- 2 Shut the mains water tap;
- 3 Drain boiler (sect. 6.3);
- 4 Drain d.h.w. section (sect. 6.4);
- 5 Dismount the microswitches as shown in sect. 6.12;
- 6 Release all the coupling nuts using No. 20,30 and 36 Open ended spanners (see fig.6.69);
- 7 Reassemble in reverse order.

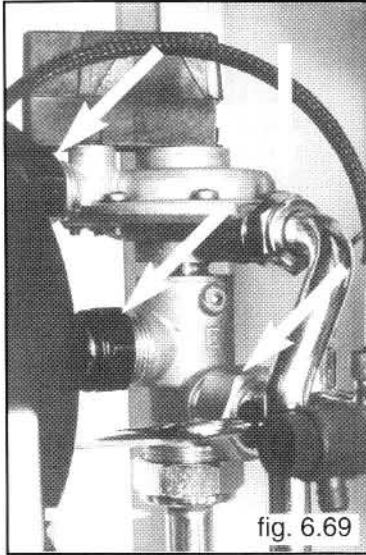

Ensure that the flat packing is in the correct position.

6.26 SECONDARY EXCHANGER

- 1 Ensure electricity is switched off at main isolator;
- 2 Drain boiler (sect. 6.3);
- 3 Drain d.h.w. section (sect. 6.4);
- 4 Remove the gas valve (sect. 6.18);

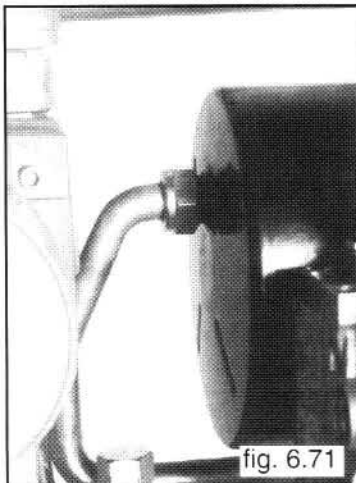
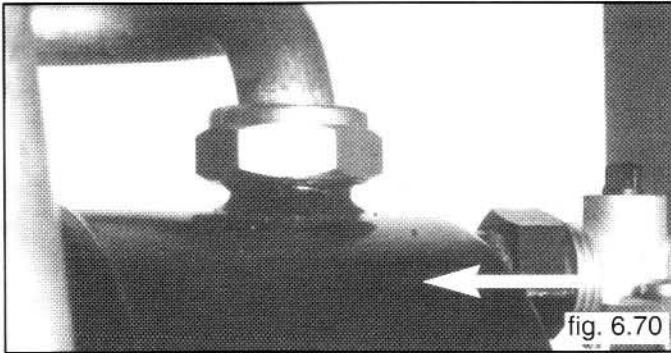

- 5 Release all the nuts as shown in figures 6.70 & 6.71 , using No.24 and 36 Open ended spanners;
- 6 Remove exchanger vessel through the front of the boiler;
- 7 Reassemble in reverse order.

6.27 EXPANSION VESSEL

- 1 Ensure electricity is switched off at main isolator;
- 2 Drain boiler (sect. 6.3);
- 3 Disconnect flue;

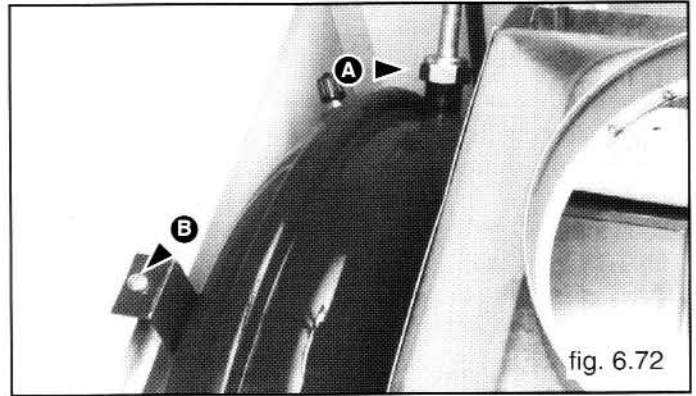

- 4 Remove nut "A" away from the expansion vessel (see fig.6.72);
- 5 Remove screw "B" using a POZI-DRIVE No.2 star tip screw-driver (see fig.6.72);
- 6 Lift expansion vessel up from the boiler;
- 7 Reassemble in reverse order.

If there is not adequate clearance the boiler must be removed from the wall before the removal procedure can be carried out.

6.28 SAFETY VALVE

- 1 Ensure electricity is switched off at main isolator;
- 2 Lower control panel (sect. 6.2);
- 3 Drain boiler (sect. 6.3);

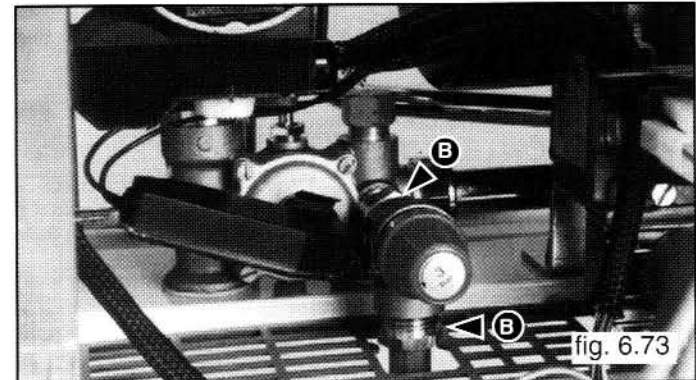

- 4 Loosen nuts B (see fig.6.73);
- 5 Remove valve;
- 6 Reassemble in reverse order

7 FAULT FINDING

7.1 TOTAL CHECK SYSTEM (TCS)

The TOTAL CHECK SYSTEM (which will be referred to as "TCS") is designed to locate faults quickly and easily. (see fig.7.1).



fig. 7.1

This device makes it possible to check the proper functioning of the electronic PCBs and components these control, it is connected to the PCB via the cable which you will see is folded back inside the TCS.

The TCS indicates:

- The actual state of the boiler;
- The eventual fault.

The informations given by the TCS are as follows (see fig.7.2):

a) n°2 LEDS EACH SIDE OF THE DISPLAY:

- green LED : the boiler work properly;
- red LED : the boiler has a fault.

b) DISPLAY SHOWING :

- the actual state of the boiler according to the following numbers:

"0"	Boiler off
"1"	Autodiagnostic state
"2"	Spark ignition stage
"3"	Boiler functioning normally
"4"	Lockout
"5"	Boiler thermostat satisfied
"6"	Room thermostat/clock no demand or selector in summer setting

- the actual faults according to the following letters:

"A"	N.A. for this model
"B"	N.A. for this model
"C"	Faulty reset switch
"D"	Faulty main circuit flow
"E"	Faulty flame detection
"F"	N.A. for this model
"G"	Flue control device operating

c) n°8 YELLOW LEDS UNDER THE DISPLAY SHOWING THE ACTUAL STATE OF THE MAIN COMPONENTS:

led 1	: Pump feeded
led 2	: Main flow switch closed
led 3	: Air pressure switch N.O. (N.A. for this model)
led 4	: Flame detected
led 5	: Water at required temperature
led 6	: Room thermostat/clock no demand or selector in summer setting
led 7	: Autodiagnosics faulty
led 8	: N.A. for this model

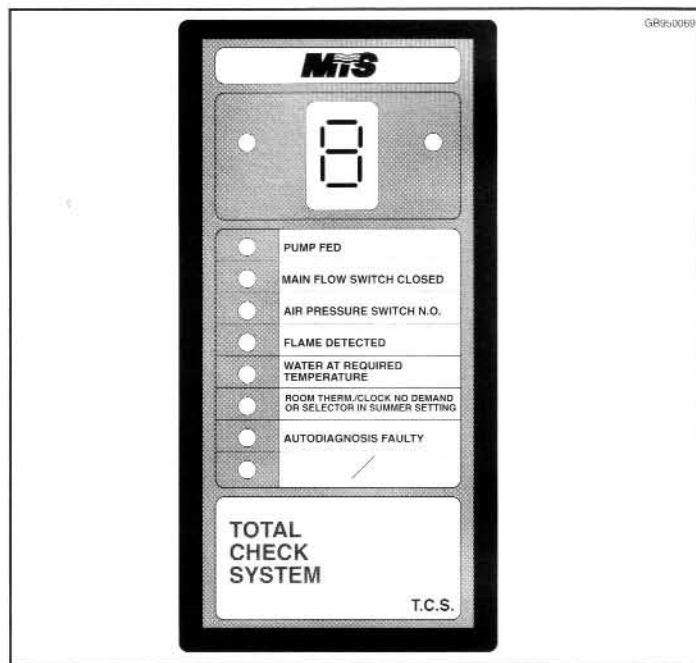

fig. 7.2

Note: During the operation of the TCS, faults may be signaled by the red LED and a letter in the display for short periods (one second or less), this is normal and does not signify these faults.

7.2 SPECIAL DEFECTS

There are special defects that can not been indicated by the TCS; these defects are treated in the following sections:

- Water leaks;
- Difficulty in lighting gas;
- Incorrect combustion;
- Traces of gas or exhaust gases in the installation area.

7.2.1 WATER LEAKS

Leaks from connectors, O-Rings or gaskets

Make sure that the surfaces which come into contact with the gaskets are free from dirt, roughness or deformation. Then substitute the gasket (both O-rings and flat gaskets).

Water leaks from safety valve

This may be caused by leaks from the d.h.w. over-pressurizing the heating circuit.

In this case remove the d.h.w. heat exchanger and replace it. If the leak only occurs when the appliance is operating, empty the main water circuit and check the pressure applied to expansion vessel (1.2 bar).

7.2.2 DIFFICULTY IN LIGHTING THE BURNER

Make sure that input and output pressures on the gas valve are set to the correct values.

Also, make sure that no pressure variations are being caused by a malfunctioning component (defective pressure reducers or regulator; dirty gas filters; other gas consuming equipment installed on the same gas line, etc.).

Fault finding

Make sure that the ignition electrodes are positioned correctly.

Make sure that injectors are clean.

7.2.3 INCORRECT COMBUSTION

Make sure that the gas modulator has been set correctly and make sure that the following elements are clean:

- Burner;
- Combustion chamber;
- Flue system.

Make sure that the exhaust flue does not return to the appliance through the air intake duct.

Make sure that the exhaust system has been properly installed.

7.2.4 TRACES OF GAS OR EXHAUST FLUES

If gas is detected in the installation area, use a soap solution or a specific leak-detection product to make sure that all the gas connectors in the system are perfectly sealed.

Check for leaks when the appliance is shut down and during operation.

If exhaust flue is detected in the installation area, make sure that the exhaust duct has been built to the exact specifications prescribed. Also, check the exhaust duct for leaks and make sure that it is clean. Make sure that all exhaust duct-work conforms to current technical standards.

7.3 INSTALLATION OF THE TCS

- 1 Remove the boiler casing and lower the control panel as described in paragraph 6.2;

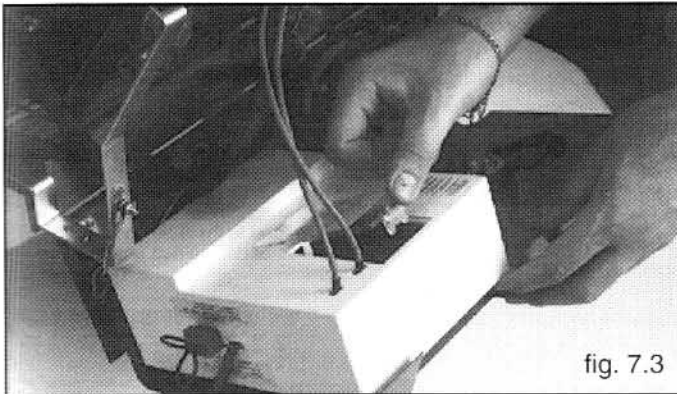

fig. 7.3

- 2 Remove the transparent back cover of the pcb (fig.7.3);

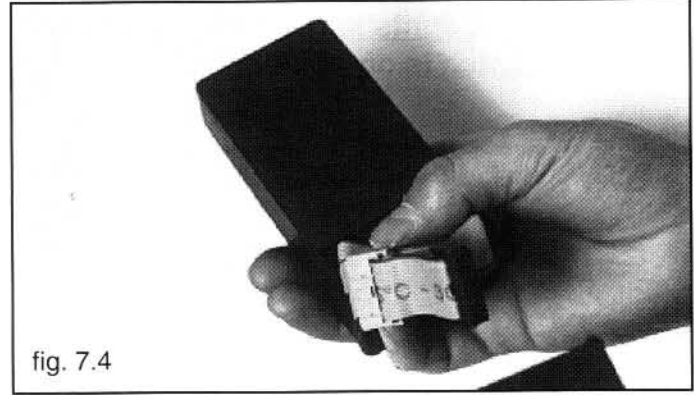

fig. 7.4

- 3 Remove the cover at the back in order to release the cable of the TCS.
You will see that there are two connectors: a black one and a grey one (see fig.7.4).

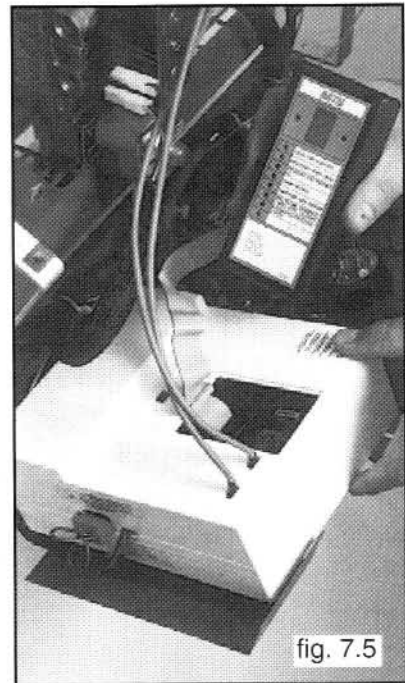

fig. 7.5

- 4 Connect the black connector to the electronic PCB (see fig.7.5).

With the boiler switch set to ON, once you have made the above connections, all the LEDs will light up and the number 8 will flash on the display for one second; this means that the TCS is ready for use.

7.4 FAULT FINDING

The TCS give all informations if the boiler is faulty or run properly.

According to the signals of the TCS, some verifications must be made and then the faults can be removed.

Follows the fault flow chart and the relative verifications according to the TCS state.

If the TCS is not available or is damaged, please follow the sequence as described at par. 7.5.

TCS STATE : All lights in the TCS are off while the main switch is on position "ON"

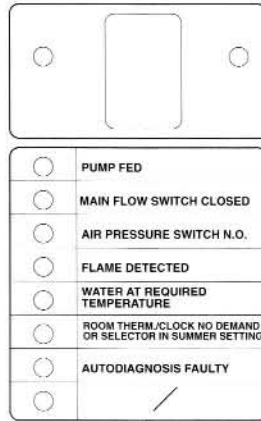

Verify preliminary that the installation of the TCS has been made properly according to the par. 7.3 and that the main switch of the boiler is on position "on" (neon light).

Yes

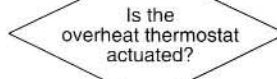

Yes

- Try to reset the thermostat (Ref.1) or replace it if needed.
The overheat thermostat is a security device that can switch off very rarely. If there are continuous interventions, it means that:
- Or the temperature regulating probes are faulty or disconnected (Ref.2) and replace if needed;
- Or the main heat exchanger is faulty due to the formation of scales or to some deposit of corrosion from the plant. In this case clean the heat exchanger according to par. 8.19 or replaced it;
- Or the fins of the main heat exchanger are not well welded to the tube; in this case all the area of not welded fins assume a black colour. Replace the heat exchanger according to par. 6.19.
- Or the PCB is faulty. In this case replace it.

No

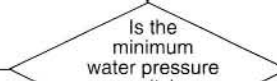

Yes

- Fill the main heating circuit according to par. 4.4. Till the pressure activates the switch in the closed position.
- If not, replace the pressure switch (Ref.4).

No

- Replace the fuses 2 A (see Ref.3).
- Locate the cause of fusing, disconnecting the components connected to the PCB and measuring their electric resistance (set tester to Ohm).
The rating values are:
- Pump : 190 Ohm
- Fan : 45 Ohm
- Control gas operators : EV1 = 870 Ohm
EV2 = 870 Ohm
Modulator = 127 Ohm

Fault finding

Ref.1

Try to reset the overheat thermostat.

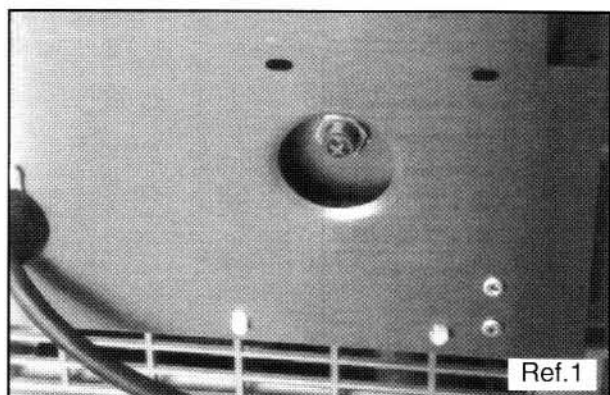

Ref.3

Replace the fuses 2A

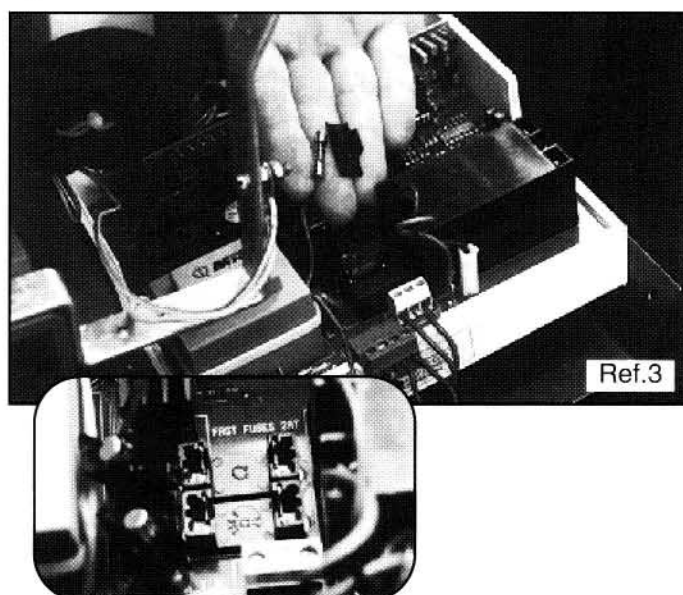

Ref.2

Verify the resistance of both heating and sanitary hot water probes.

The resistance must be according to the following table:

WATER TEMPERATURE (DEGREES)	RESISTANCE ($\kappa \Omega$)
30	8.170
35	6.750
40	5.750
45	4.750
50	4.240
55	3.470
60	2.950
65	2.600
75	1.900
80	1.665
85	1.442
90	1.202

Ref.2

Ref.4

Verify if the minimum water pressure switch is in the closed position.

Set the tester to Ohm.

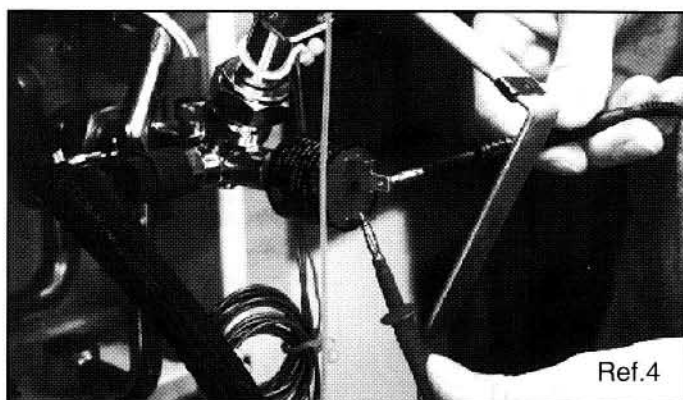

TCS STATE : Resetting switch pressed
 (letter "C" appears during the autodiagnosis if the reset switch is pressed or in short circuit)



	PUMP FED
	MAIN FLOW SWITCH CLOSED
	AIR PRESSURE SWITCH N.O.
	FLAME DETECTED
	WATER AT REQUIRED TEMPERATURE
	ROOM THERM./CLOCK NO DEMAND OR SELECTOR IN SUMMER SETTING
	AUTODIAGNOSIS FAULTY

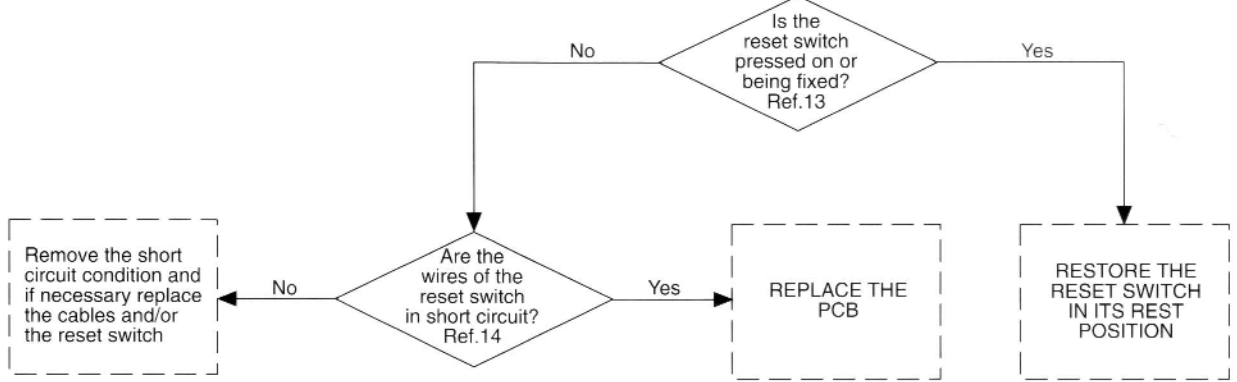

Ref.13
 The check can be done just visually.

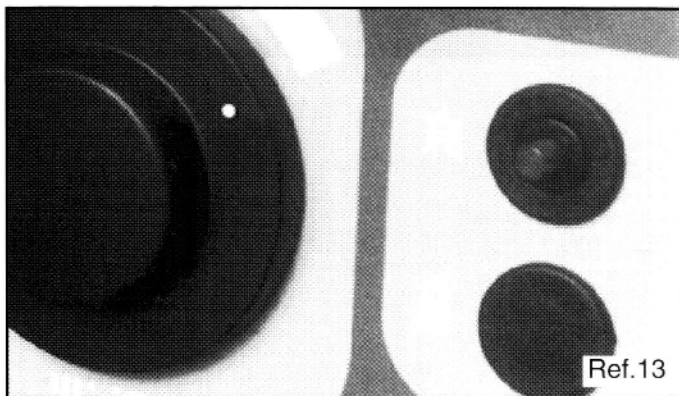

Ref.14
 Verify that the resistance between the two pin is infinity.
 Set the tester to Ohm.



Fault finding

TCS STATE : **Main water flow faulty**

(letter "D" appears before the autodiagnosis:

(two cases are possible depending from the led lighting)

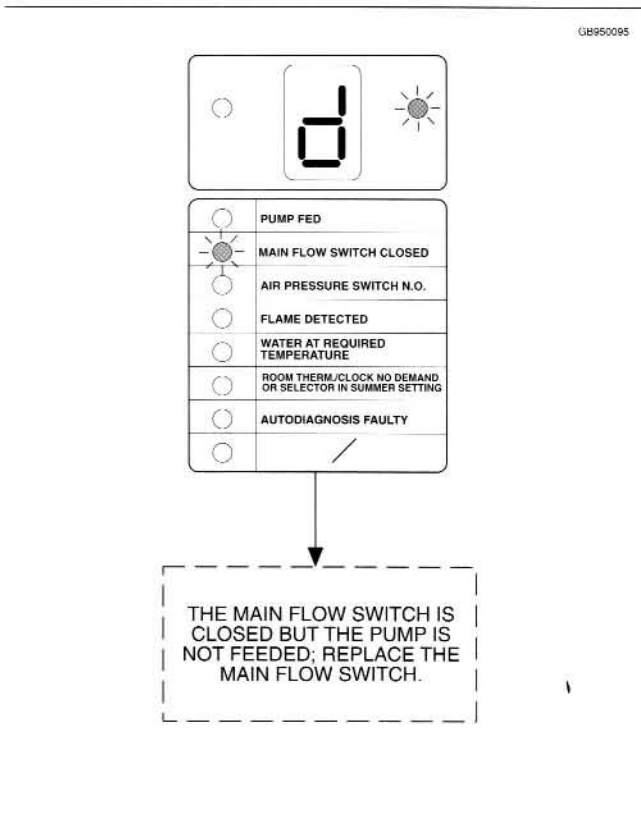
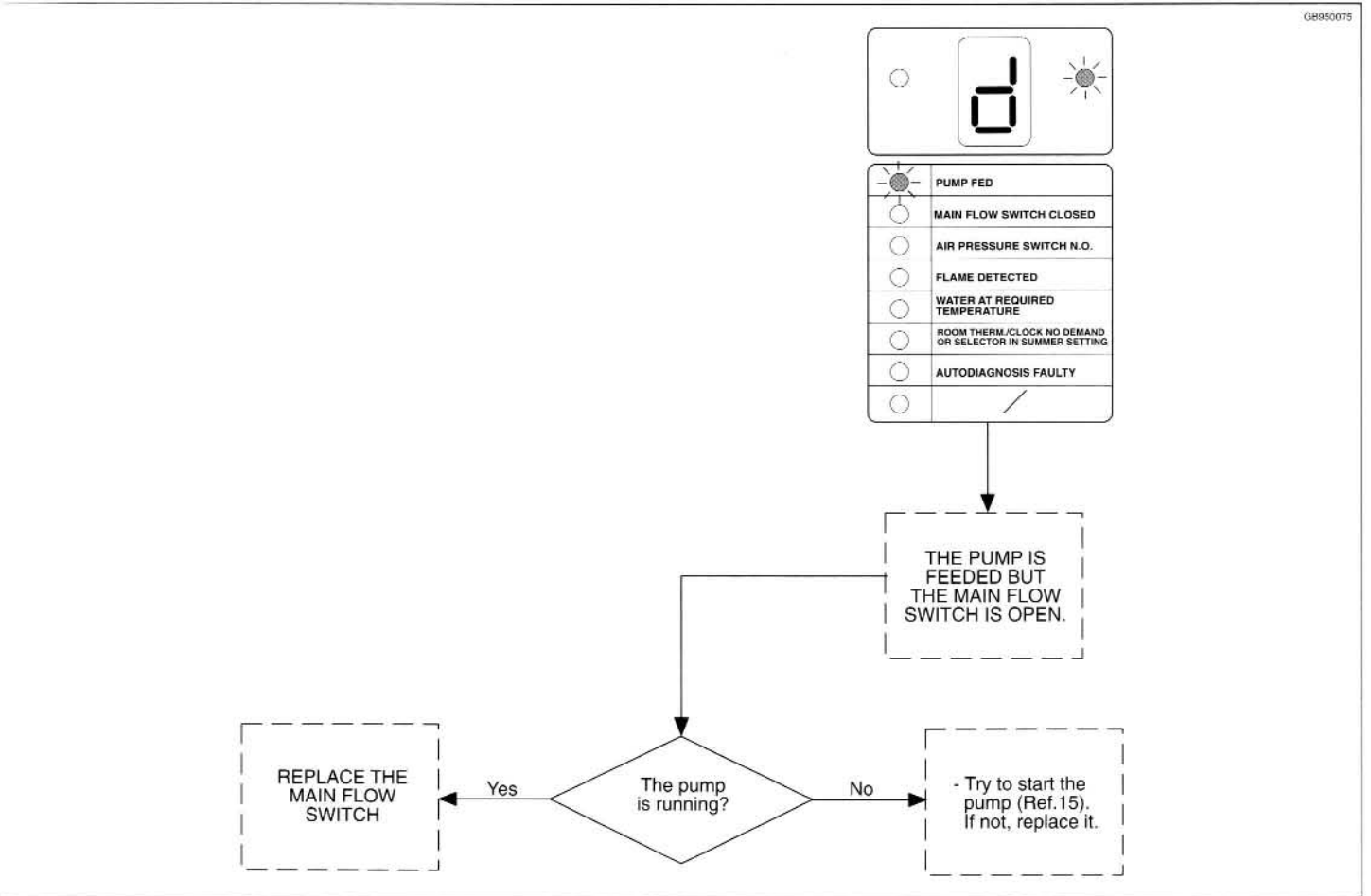

Ref.15

Remove the screw cap and then turn the shaft of the pump in clockwise direction.

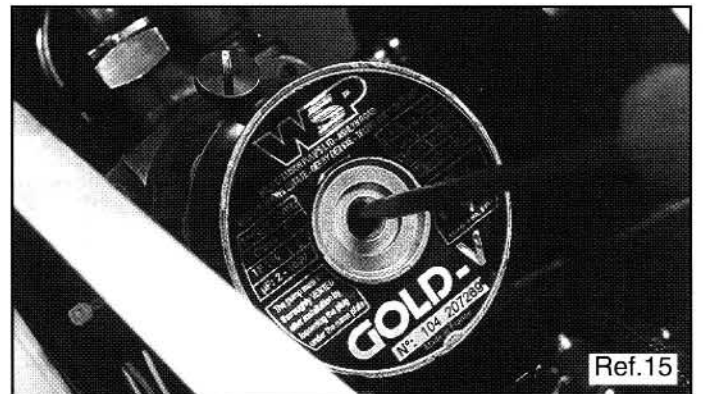

TCS STATE : **Faulty flame supervision device**

(letter "E" appears during the autodiagnostic if there is a supervised flame before opening the gas valve)

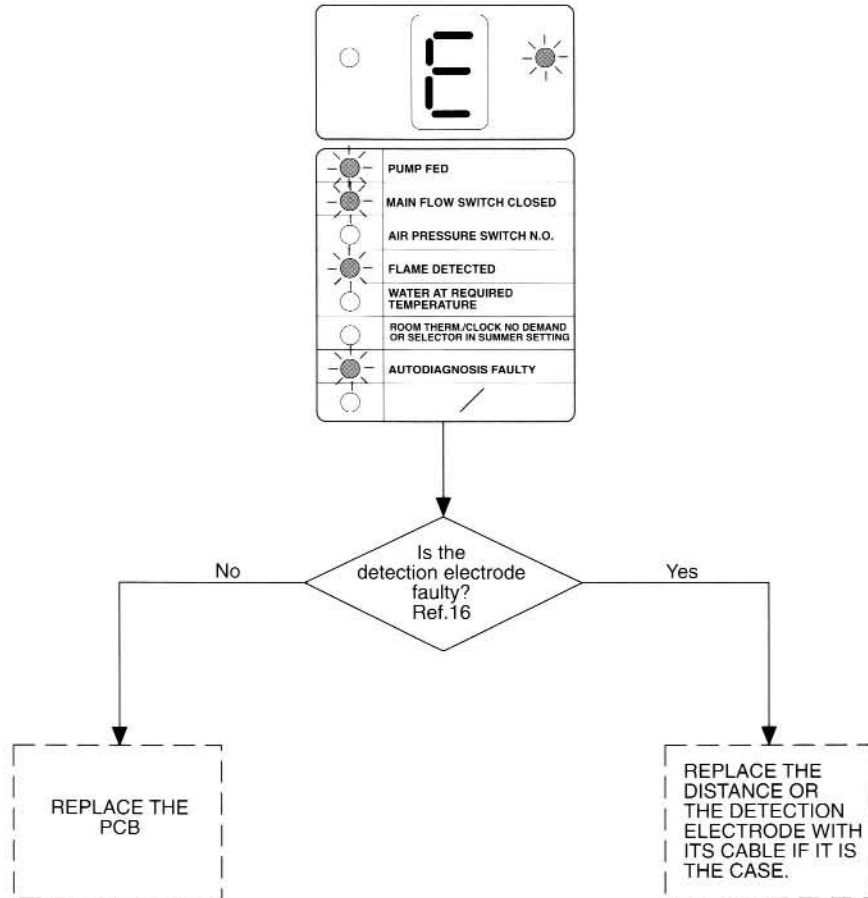

Ref.16

Verify the distance of the terminal of the detection electrode to the burner; it should be about 5 ÷ 7 mm (see Fig. Ref.11-a).

Set the tester to DC (µA).

The tester should be connected in serie with the detection circuit (see Fig. Ref.11-b).

The value of detection current without flame must be lower than 0.5 µA.

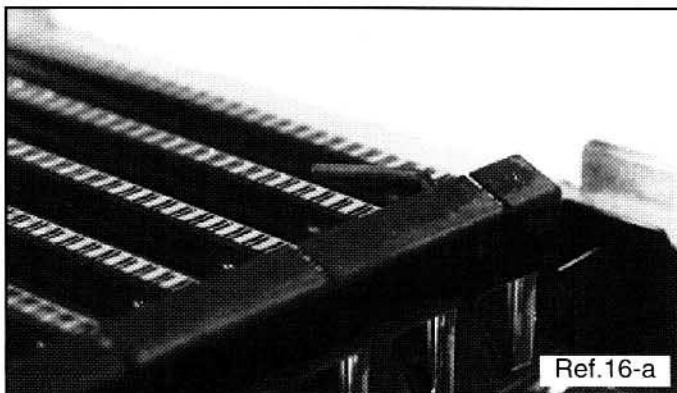

Fault finding

TCS STATE : Flue device control faulty

GB950072

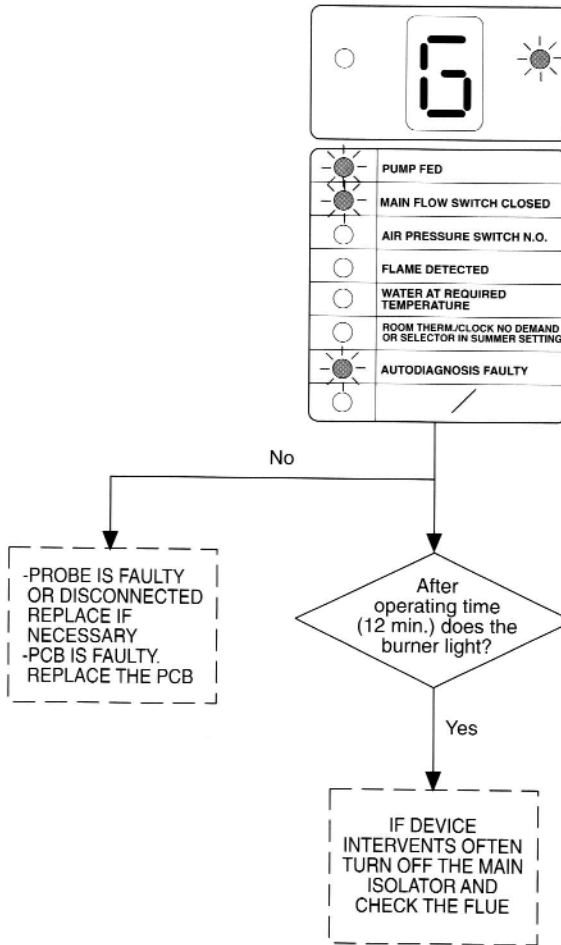

GB950073

TEMPERATURE (DEGRESS)	RESISTANCE ($\kappa \Omega$)		
	MIN.	NOM.	MAX
20	122,300	126,700	131,130
30	77,000	79,000	82,000
40	49,000	51,000	53,000
50	32,000	33,500	35,000
60	21,500	22,000	24,000
70	15,000	16,000	16,800
75	12,300	13,200	14,000
80	10,300	11,000	11,900
85	8,600	9,300	10,000
90	7,200	7,900	8,500
95	6,100	6,700	7,200
100	5,200	5,700	6,000

Fault finding

GB95007

TCS STATE : **Lockout (red light on the reset push button)**

(number "4" appears if the flame is not detected:

- 1 - or at the end of a complete ignition sequence;
- 2 - or when, as a consequence of a disappearance of the flame without the gas supply having been interrupted, the ignition device faults).

Note: A single lockout is a not default; just repetitive lockout are a default.

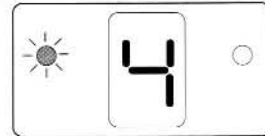

<input checked="" type="checkbox"/>	PUMP FED
<input checked="" type="checkbox"/>	MAIN FLOW SWITCH CLOSED
<input type="checkbox"/>	AIR PRESSURE SWITCH N.O.
<input type="checkbox"/>	FLAME DETECTED
<input type="checkbox"/>	WATER AT REQUIRED TEMPERATURE
<input type="checkbox"/>	ROOM THERM./CLOCK NO DEMAND OR SELECTOR IN SUMMER SETTING
<input checked="" type="checkbox"/>	AUTODIAGNOSIS FAULTY

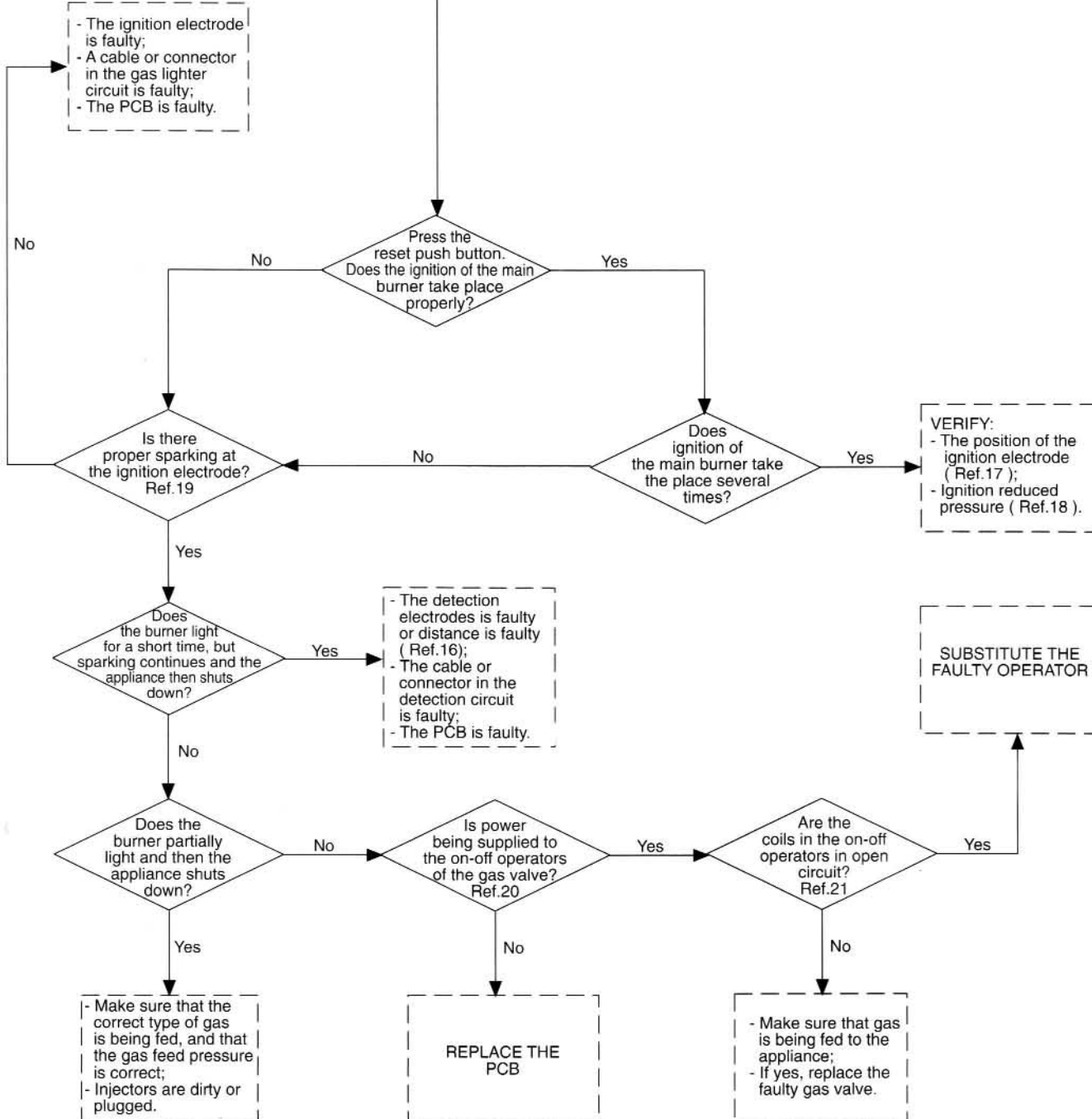

Fault finding

Ref.17

Verify that the distance between the terminal of the ignition electrode and the burner as about 5 mm.

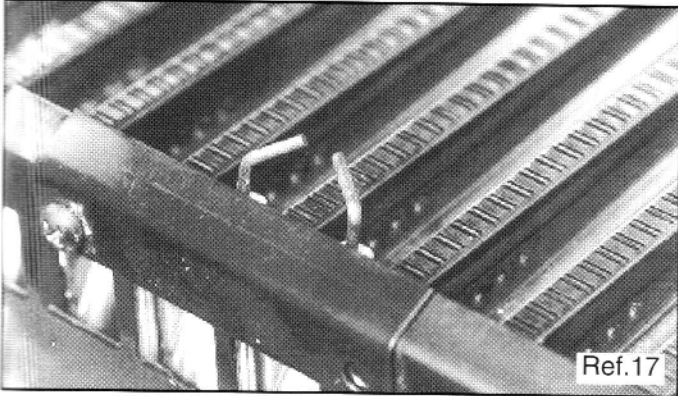

Ref.20

Supply voltage should be indicated when power is supplied to the operators.

Make measurements with the device reset from shut-down.

Set the tester to VAC.

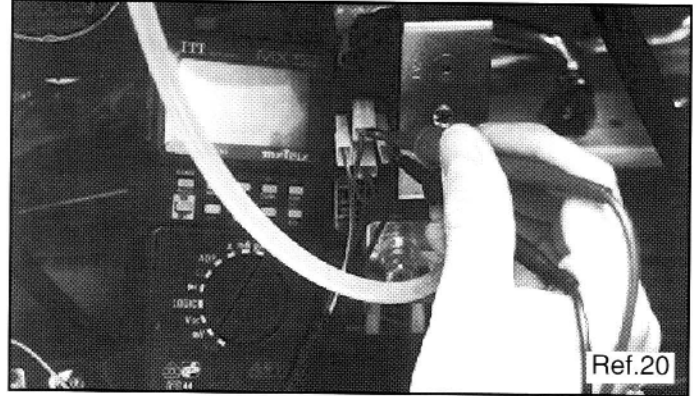

Ref.18

Install a manometer in the outlet pressure intake of the gas valve.

Remove the detection electrode and activate an ignition cycle.

During this attempt the ignition, gas pressure can be measured.

Verify that this value is according to the installation booklet.

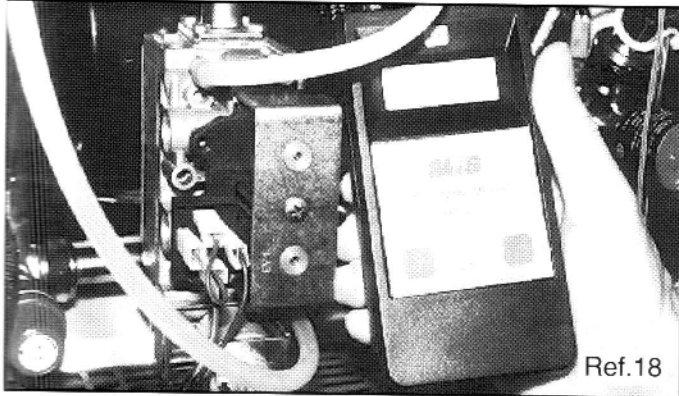

Ref.21

To check the coil in the on-off operators, disconnect the winding from its circuit and measure the resistance; it must be not infinity.



Ref.19

Verify visually that sparks are on the burner and distance is according to ref.17.

Fault finding

GB950076

TCS STATE : There is no demand of heat due to the internal regulations of the boiler

Note: This state is faulty only if it remains indefinitely, even when space heating or domestic hot water are expected.

Chw : Central heating water

Dhw : Domestic hot water

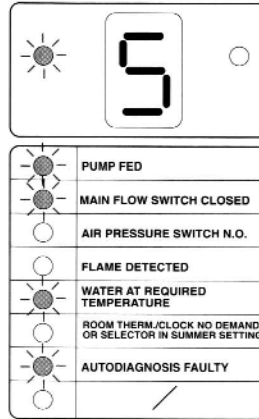

- In case of space heating, put the Chw potentiometer to its maximum and wait till the temperature is lower then required;
 - In case of domestic hot water be sure that the flow rate of the drawing is greater than 2.8 litres/minute.

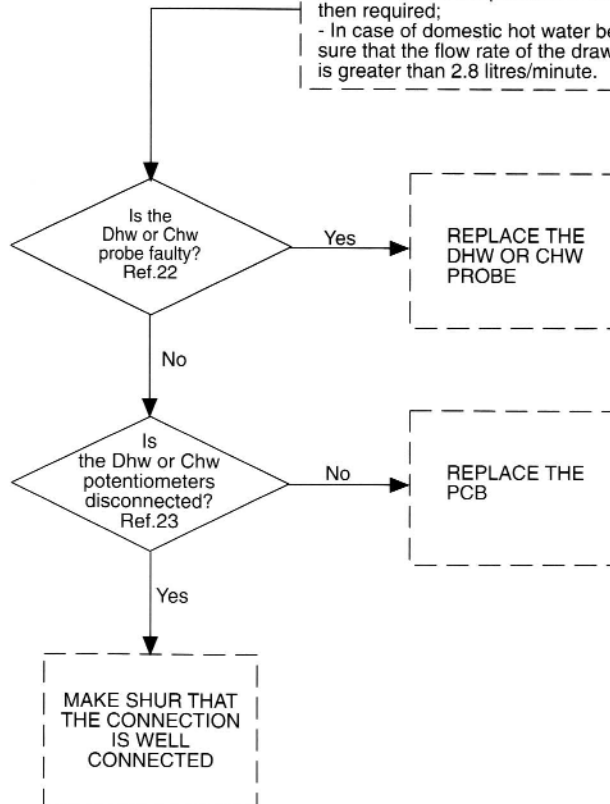

Fault finding

Ref.22

Disconnect the terminals of the probe and make measurements of the resistance. Set the meter to Ohm. The valve must be according to those of Ref.2

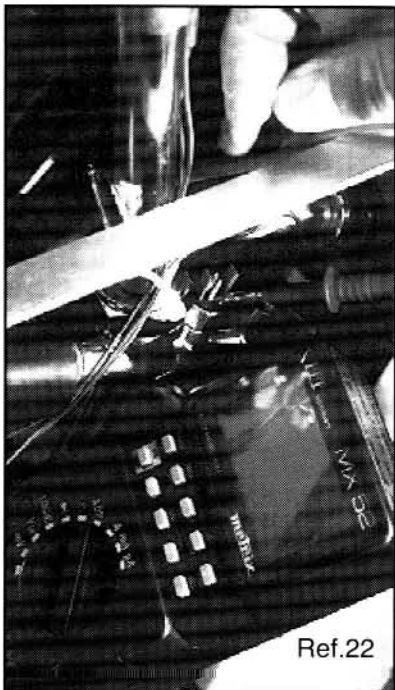

Ref.23

Verify visually if the connector to the potentiometer is well connected.

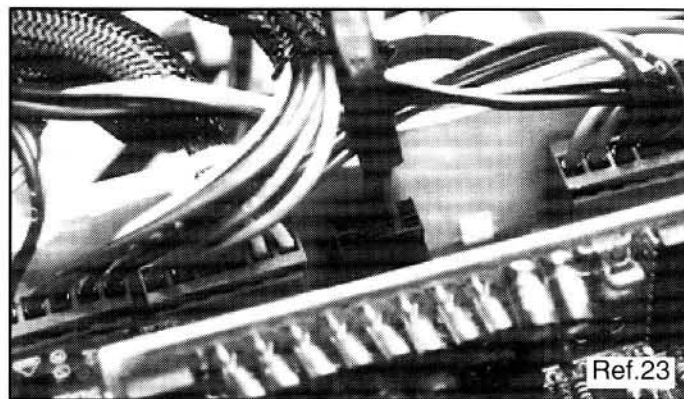

Fault finding

GR960079

TCS STATE : There is no demand of heat due to the external regulations of the boiler or boiler is switched on "summer" position.

Note: This state is faulty only if it remains indefinitely, even when space heating or hot water are expected.

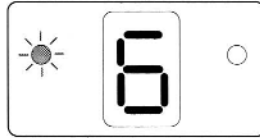

<input type="checkbox"/>	PUMP FED
<input type="checkbox"/>	MAIN FLOW SWITCH CLOSED
<input type="checkbox"/>	AIR PRESSURE SWITCH N.O.
<input type="checkbox"/>	FLAME DETECTED
<input checked="" type="checkbox"/>	WATER AT REQUIRED TEMPERATURE
<input checked="" type="checkbox"/>	ROOM THERM./CLOCK NO DEMAND OR SELECTOR IN SUMMER SETTING
<input checked="" type="checkbox"/>	AUTODIAGNOSIS FAULTY

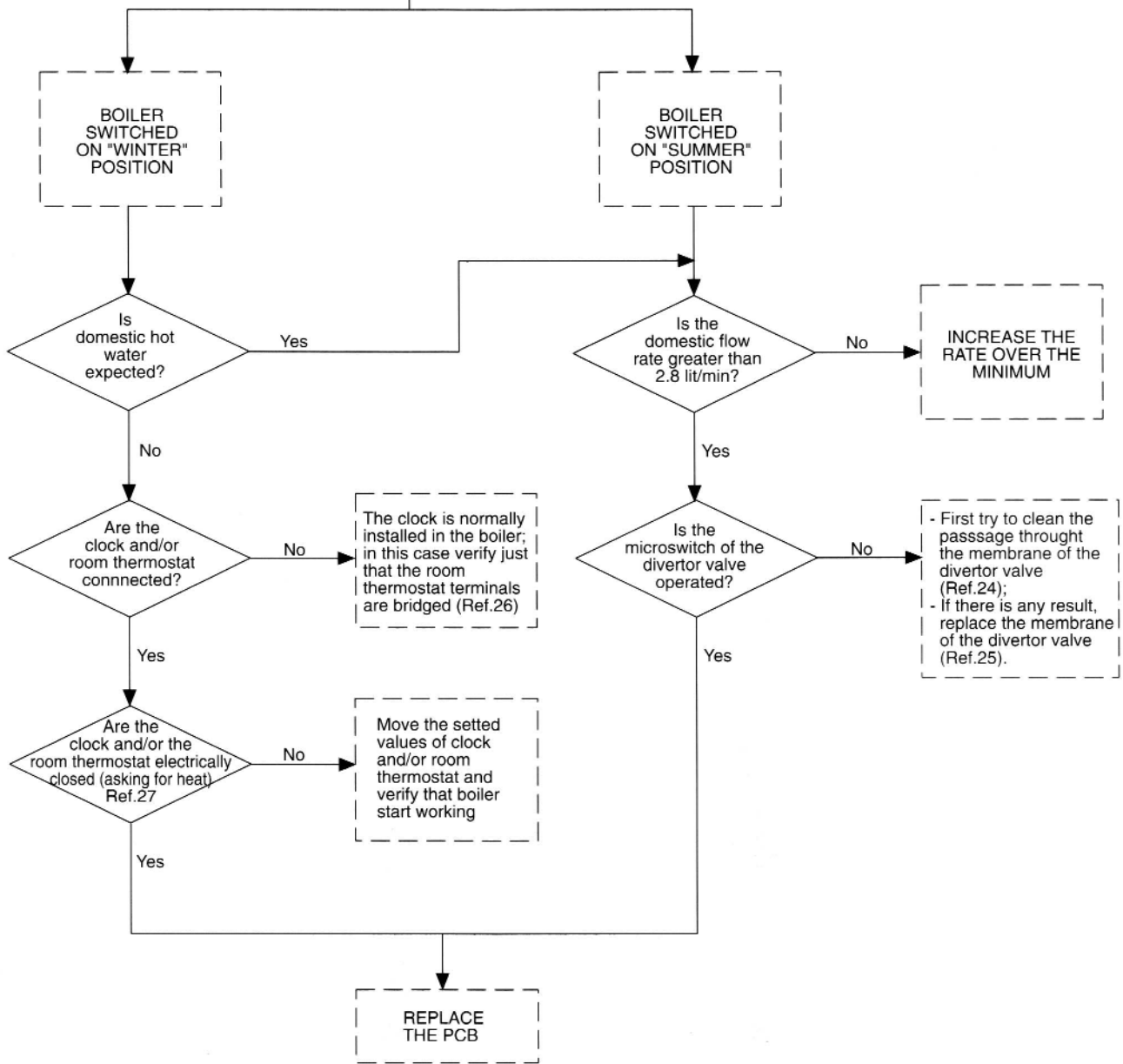

Fault finding

Ref.24

Do as follows:

- Increase the domestic water flow rate to the maximum;
- Push back the shaft of the diverter (with a tool); wait some seconds.



Ref.27

Measure the resistance between the terminals of the clock and /or the room thermostat.

The value must be zero.

Set the tester to Ohm.

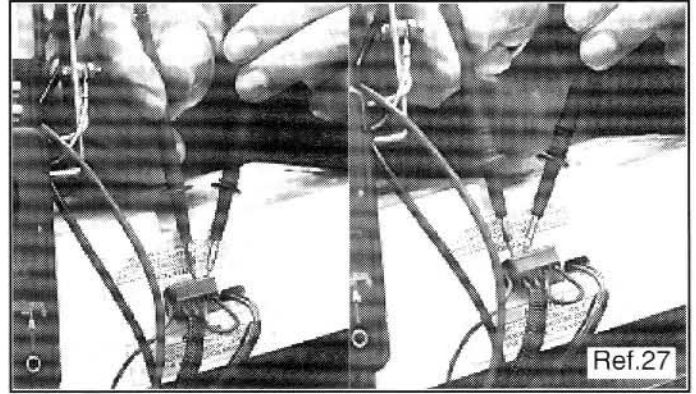

Ref.25

- Switch off the domestic inlet cock;
- Remove the 8 screws;
- Unloose the nut connecting the diverter valve to the sanitary heat exchanger;
- Dismount the brass up and replace the membrane.

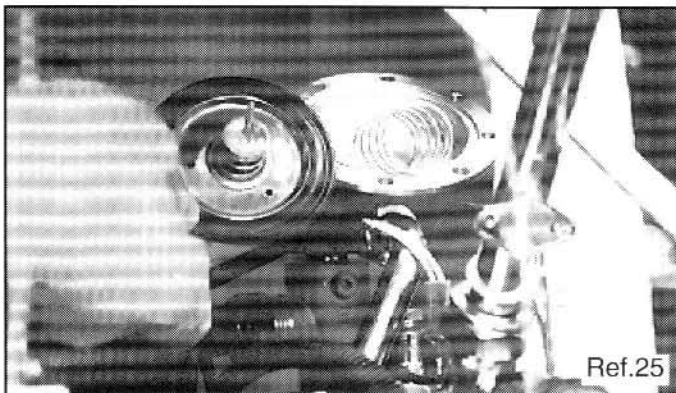

Ref.28

Measure first that supply voltage is supplied to the pump.

Set the tester to VAC.

Then measure the resistance of the windings of the pump it must be not lower than 190 Ω and not infinity.

Set tester to Ohm.

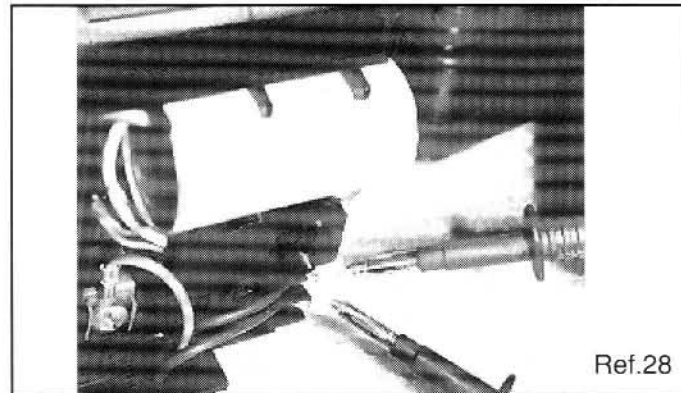

Ref.26

Verify that the electric bridges of the clock and/or room thermostat are installed (when clock and/or room thermostat are not connected).

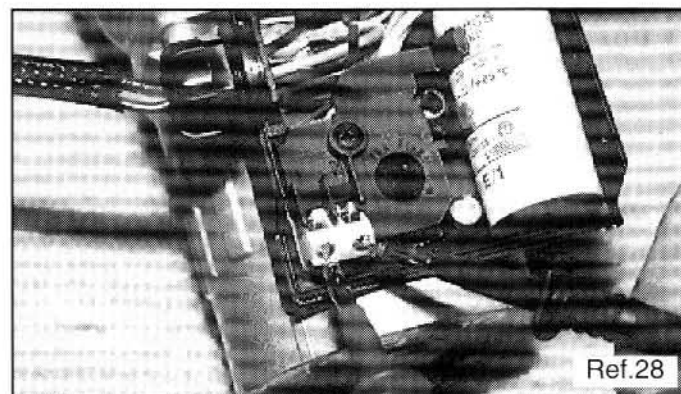
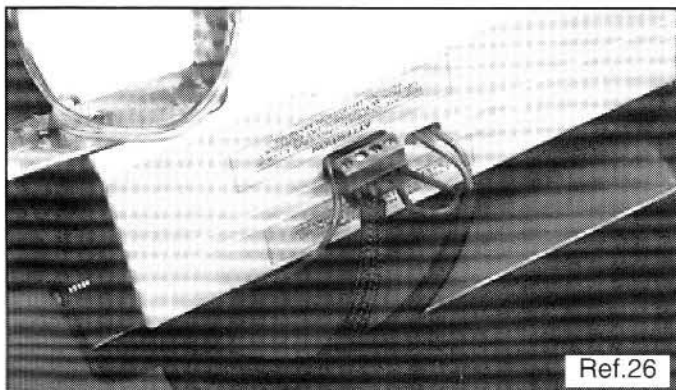

Ref.29

Disconnect the terminals of the flow switch and make measurements of the resistance that must be zero.

Set tester to Ohm.

Fault finding

7.5 FAULT FINDING WITHOUT THE UTILIZATION OF THE TOTAL CHECK SYSTEM

The utilization of TCS is the more efficient way to single out a defect, because its message let only a restricted area to be checked.

But in the case of TCS not availability, it is possible to detect and remove the eventual defect utilizing the standard fault finding diagrams described in this chapter.

The checking modes referred to are the same as with utilization of TCS.

7.5.1 APPLIANCE COMPLETELY SHUT DOWN

INITIAL CONDITIONS:

- The main switch is on position "ON" (neon light);
- The boiler is switched on "WINTER" position.

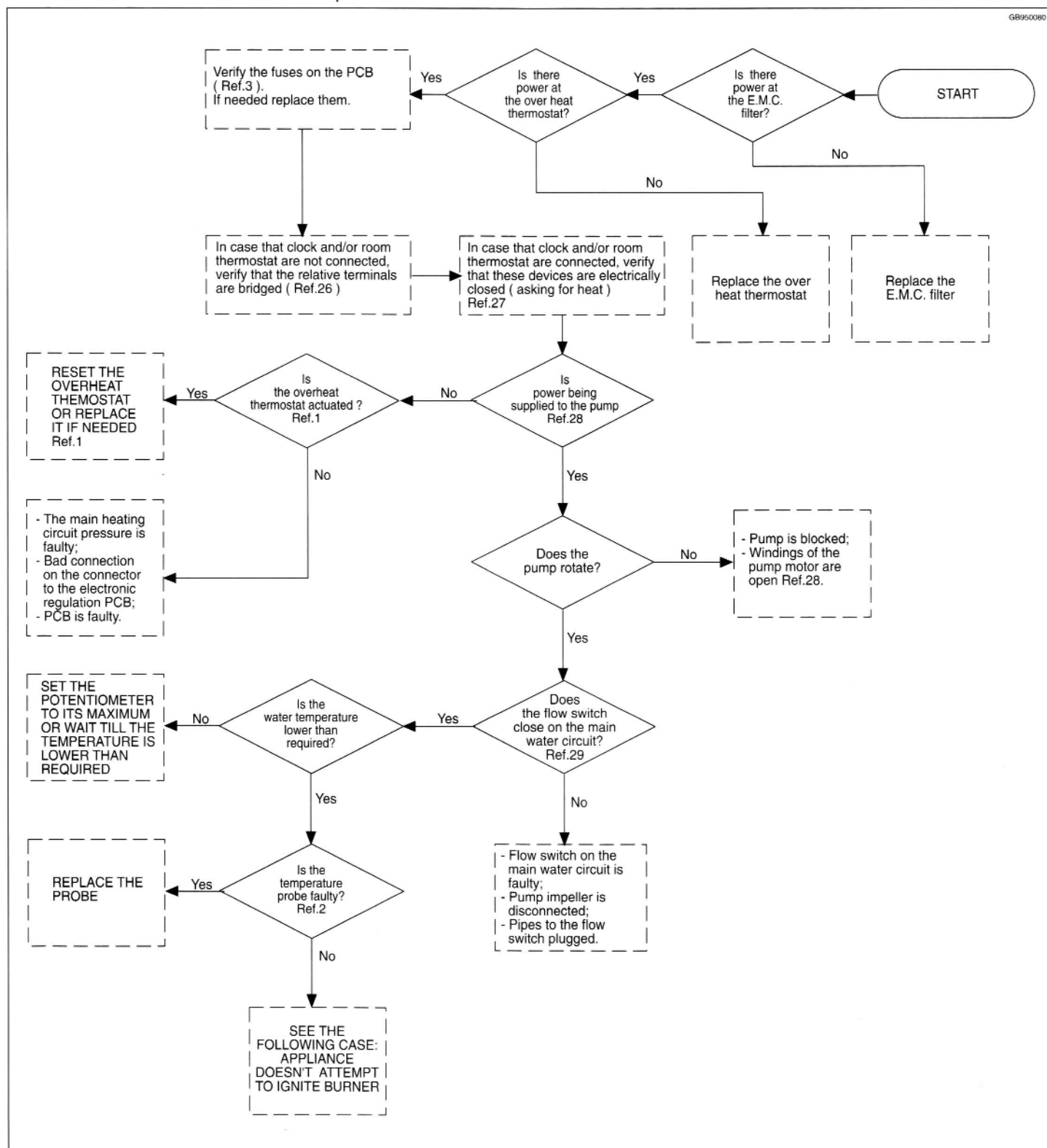

Fault finding

TCS STATE : Flue device control faulty

GB950088

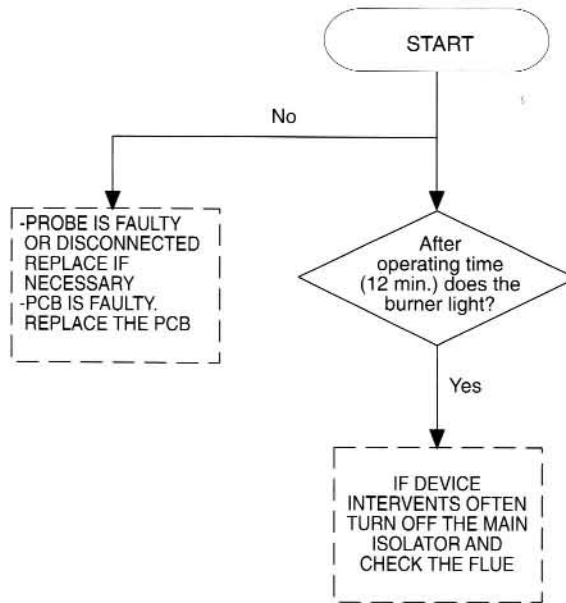

GB950073

TEMPERATURE (DEGRESS)	RESISTANCE ($\kappa \Omega$)		
	MIN.	NOM.	MAX
20	122,300	126,700	131,130
30	77,000	79,000	82,000
40	49,000	51,000	53,000
50	32,000	33,500	35,000
60	21,500	22,000	24,000
70	15,000	16,000	16,800
75	12,300	13,200	14,000
80	10,300	11,000	11,900
85	8,600	9,300	10,000
90	7,200	7,900	8,500
95	6,100	6,700	7,200
100	5,200	5,700	6,000

7.5.2 APPLIANCE FAIL FREQUENTLY IGNITION WITH CONSEQUENT LOCKOUT (RED LIGHT ON THE RESET PUSH BUTTON)

INITIAL CONDITIONS:

- The main switch is on position "ON" (neon light);
- The boiler is switched on "WINTER" or "SUMMER" position;
- Space heat or hot water are expected.

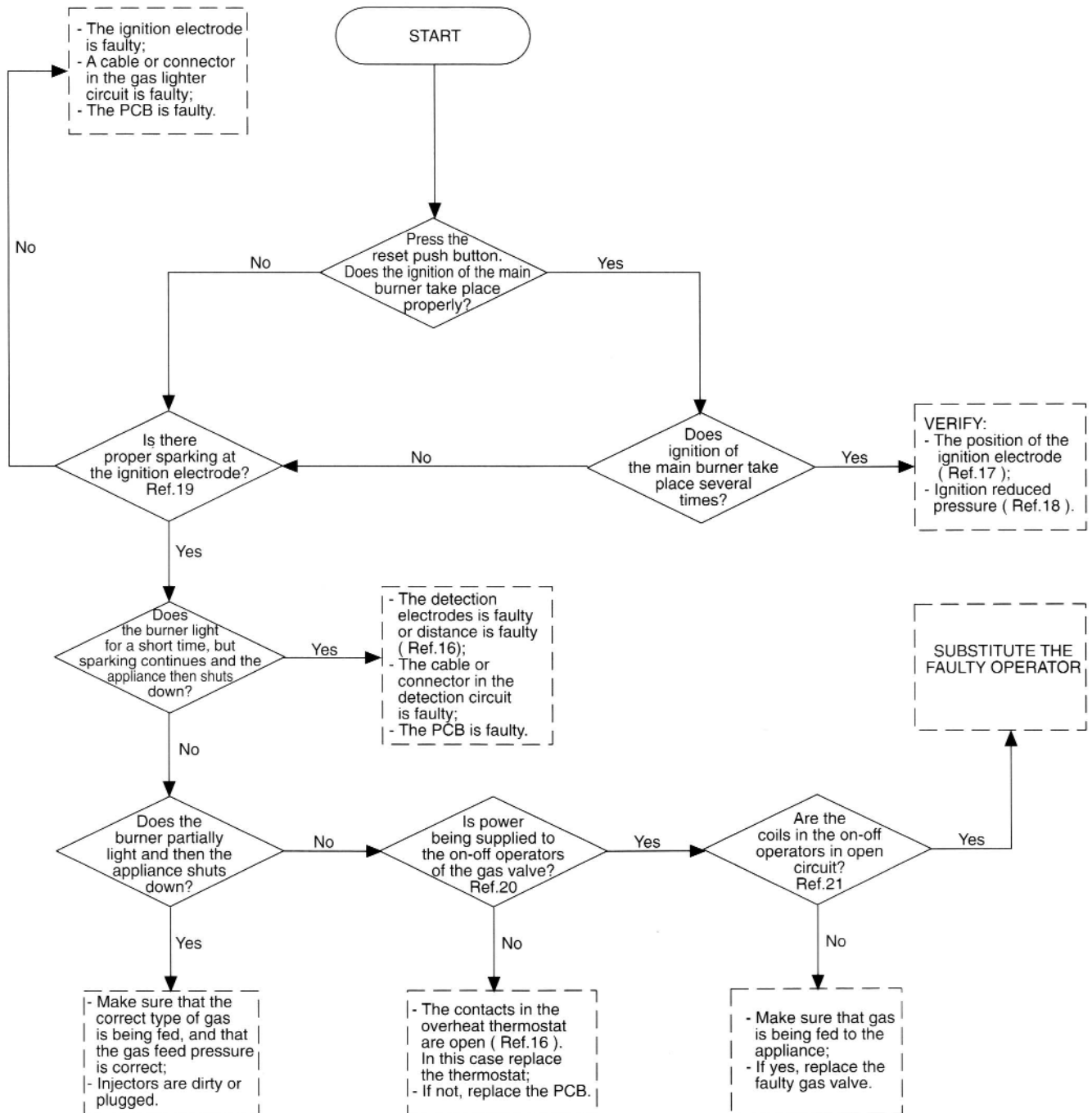

7.5.3 FAULT ON "HOT WATER - SPACE HEATING" SWITCHING

INITIAL CONDITIONS:

- The main switch is on position "ON" (neon light);
- The boiler is switched on "WINTER" position;

CASE A : The appliance operates in the central heating mode only and not in hot water mode.

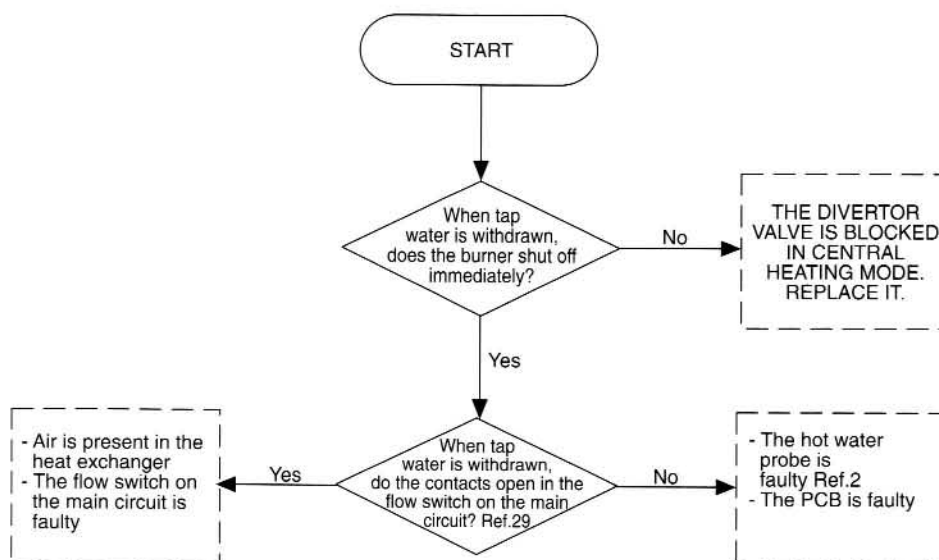

CASE B : The appliance operates in the hot water mode only and not in central heating mode.

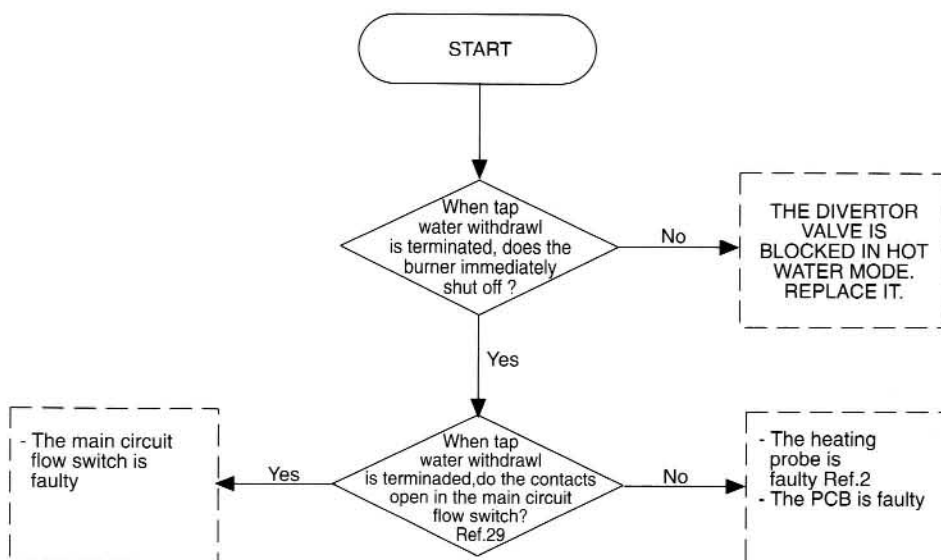

8 ELECTRIC DIAGRAMS

8.1 ELECTRICAL CONNECTION

GB950084

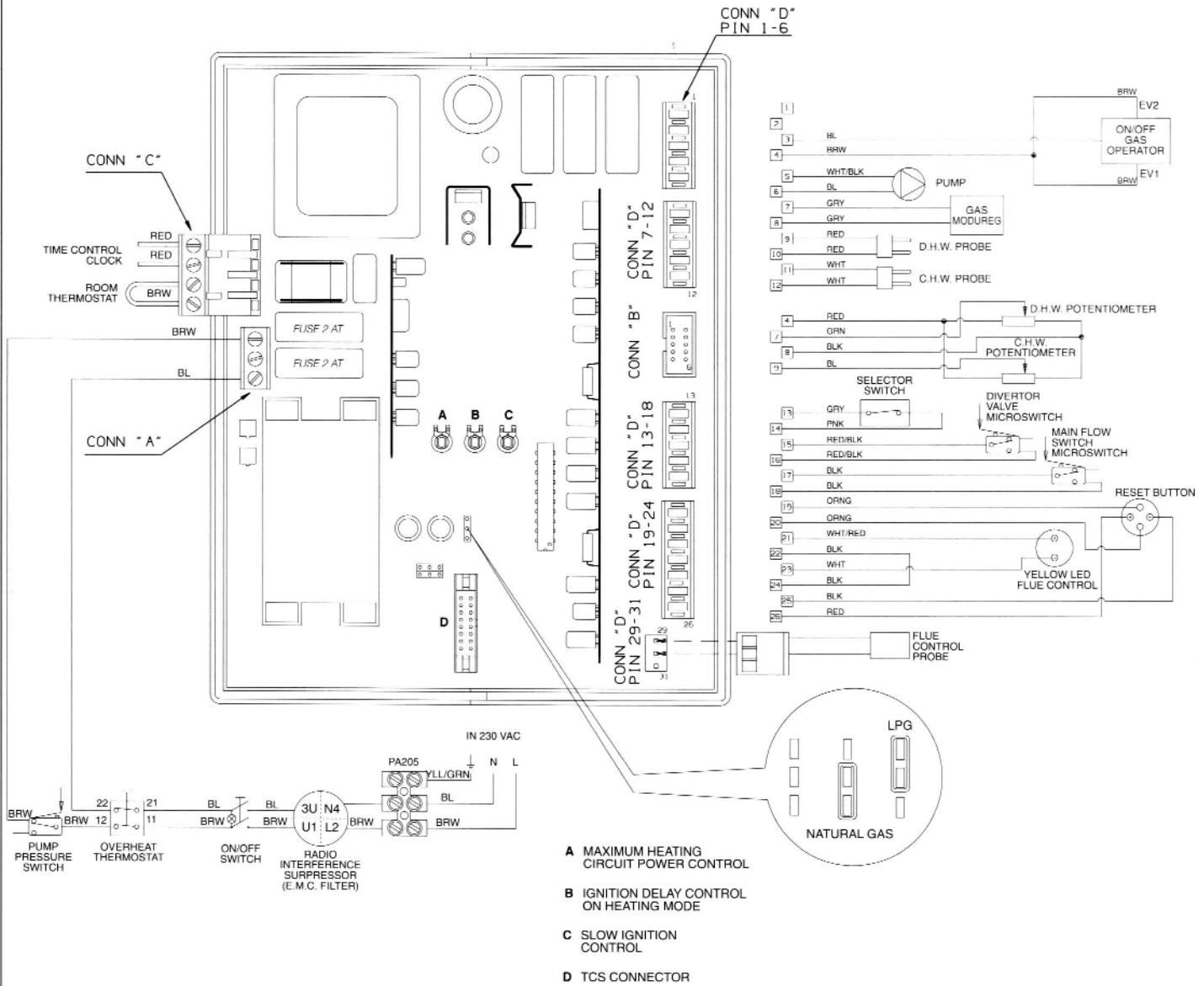

COLOUR

- Bl =Blue
- Red =Red
- Brw =Brown
- Blk =Black
- Gry =Grey
- Vio =Violet
- Wht =White
- Pnk =Pink
- Grn =Green
- Orng =Orange
- Yll/Grn =Yellow/Green
- Wht/Blk =White/Black
- Wht/Red =White/Red
- Red/Blk =Red/Black

- A MAXIMUM HEATING CIRCUIT POWER CONTROL
- B IGNITION DELAY CONTROL ON HEATING MODE
- C SLOW IGNITION CONTROL
- D TCS CONNECTOR

3.2 FUNCTIONAL FLOW CONNECTION

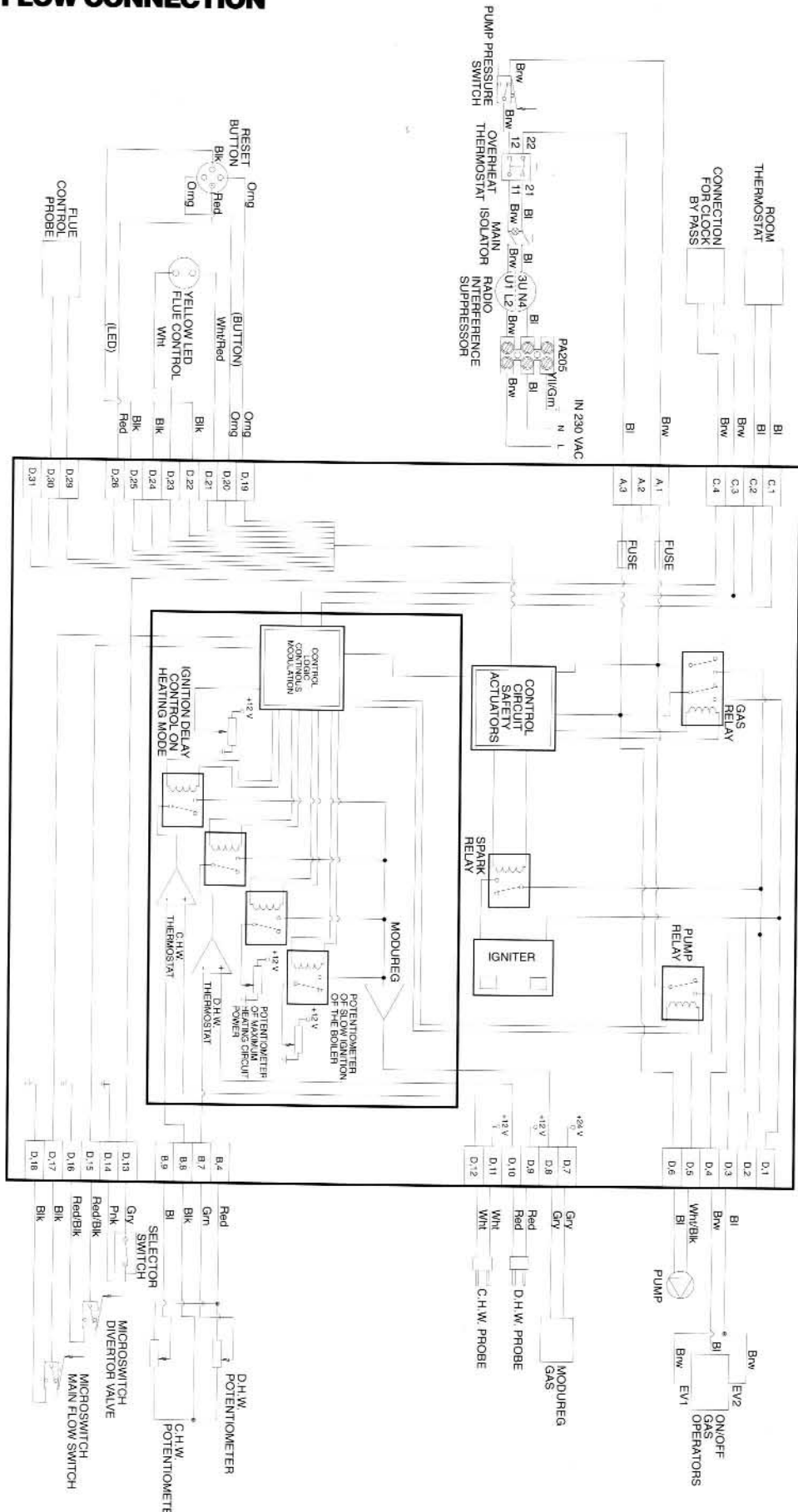

COLOUR

- Bl = Blue
- Red = Red
- Brw = Brown
- Blk = Black
- Gry = Grey
- Vio = Violet
- Wht = White
- Pnk = Pink
- Grn = Green
- Org = Orange
- Yll/Grn = Yellow/Green
- Wht/Blk = White/Black
- Wht/Red = White/Red
- Red/Blk = Red/Black

9 SHORT SPARE PARTS LIST DIA 24

Key no.	G.C. part no.	Description	No.	ARISTON Part No.
1	379 816	Expansion vessel	1	564492
10	164 225	3/4" gasket	12	573520
14	379 079	Automatic air release valve	1	564254
15	164 282	3/8" gasket	3	573521
16	164 230	1" gasket	3	569387
17		Pump	1	570931
19	164 229	1/2" gasket	8	573528
21		Safety valve	1	569292
22	164 261	1/4" gasket	4	569390
30	379 080	Pump pressure switch	1	570605
36		Yellow flue control led	1	570651
37	379 824	Wired reset button	1	560171
40	379 818	Temperature - pressure gauge	1	573586
44	379 817	Overheat thermostat	1	573805
47		Flue control probe	1	570568
52CD		Front combustion chamber insulation panel	1	573722
54CD		Back combustion chamber insulation panel	1	573724
56C		Main burner natural gas	1	570928
56D		Main burner LPG	1	570929
57	164 259	Side combustion chamber insulation panel	2	573720
59	164 270	D.h.w. exchanger	1	566098
62		C.H.W. Probe / D.H.W. probe	2	569236
63	379 821	Divertor valve (without microswitches)	1	560166
68		Gas valve SIT TANDEM	1	570732
69		P.C.B.	1	950961
75		Radio interference suppressor	1	570995
78		Detection electrode	1	573441
79		Right ignition electrode	1	569560
80		Left ignition electrode	1	569561
81AC		Burner jet 1,25ø	15	570248
81BD		Burner jet 072ø	15	570251
85CD	164 277	Main heat exchanger	1	569562
323		Gas modulator cartridge	1	573745
324		Fast fuse 2AT	2	950030

Short spare parts list

950295

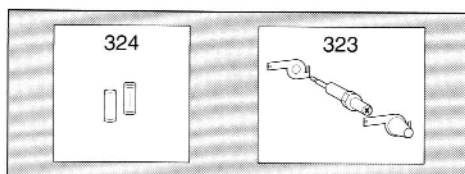
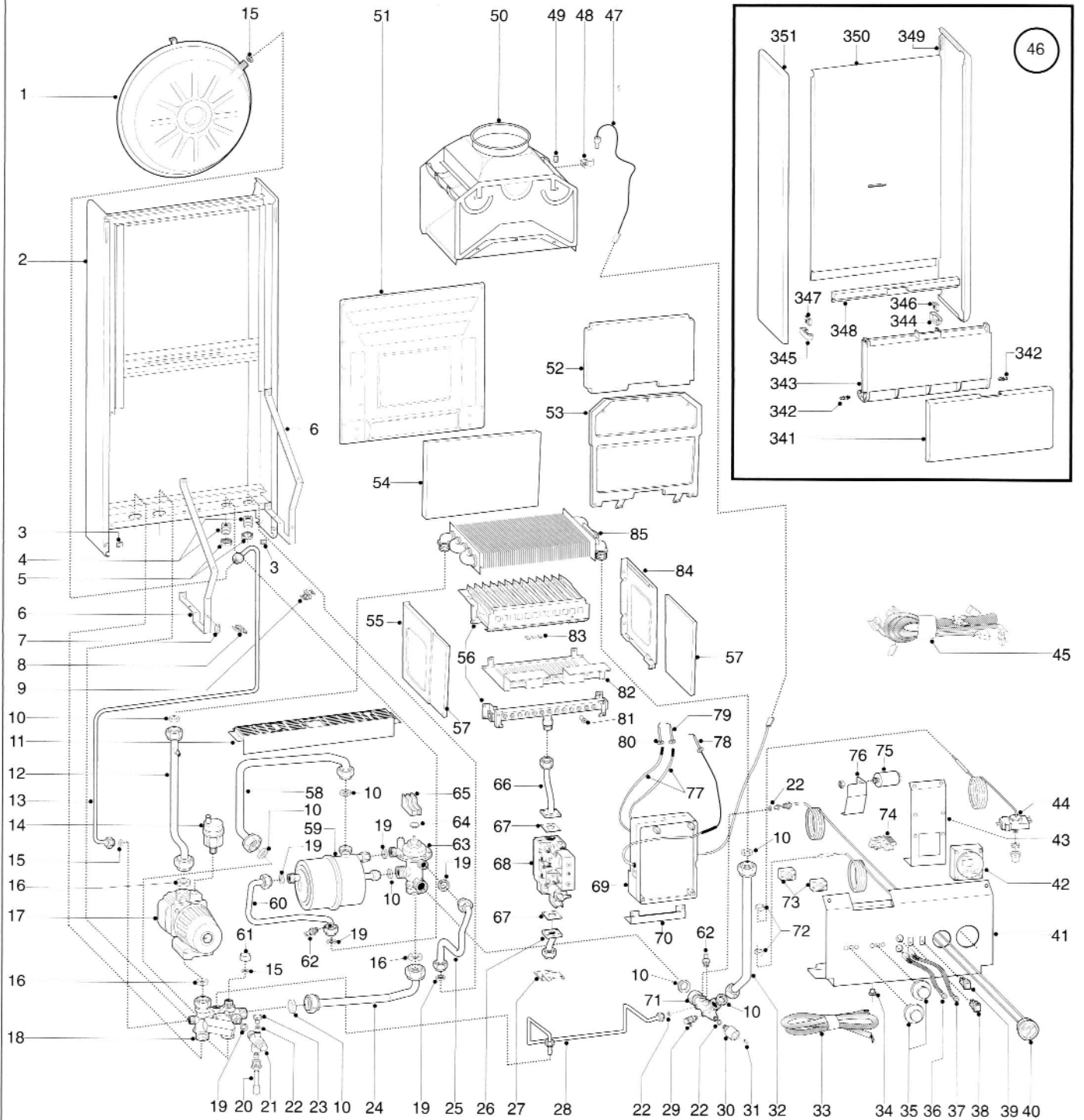

CONTROL PANEL

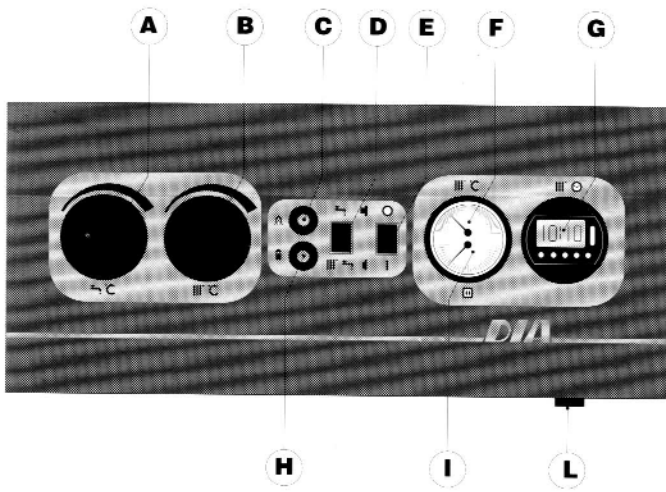

- A: Domestic hot water temperature control
- B: Central heating temperature control
- C: Red warning light
- D: Summer/winter switch
- E: On/off switch with neon light
- F: Central heating flow temperature gauge
- G: Central heating time control clock
- H: Yellow flue control light
- I: Water pressure gauge
- L: Safety thermostat reset

RESIDUAL HEAD OF THE CIRCULATOR GOLD

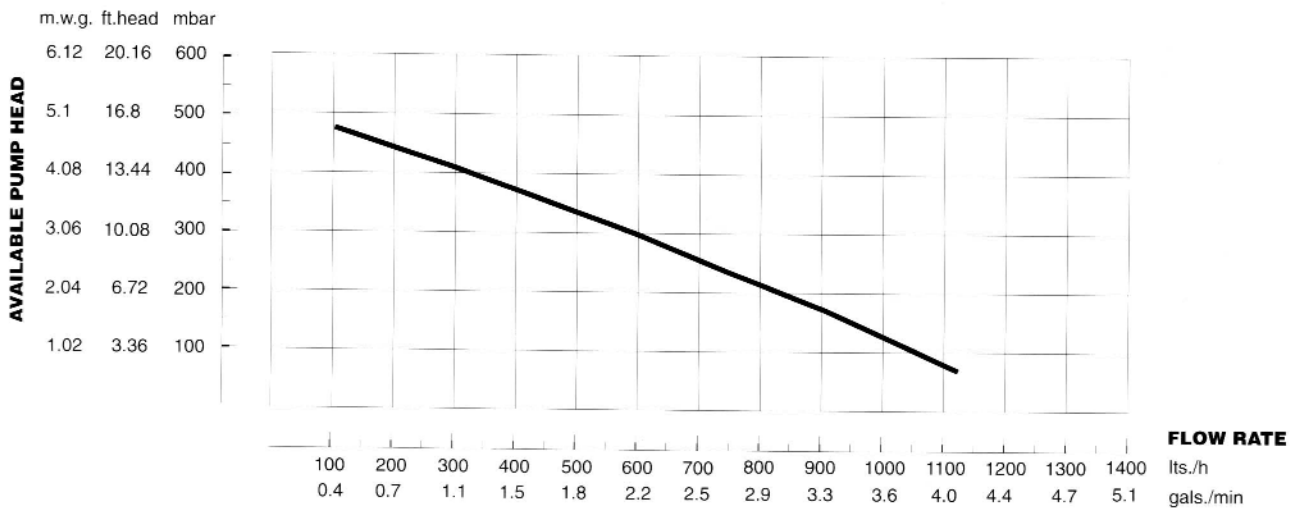

RESIDUAL HEAD OF THE CIRCULATOR GOLD-STAR

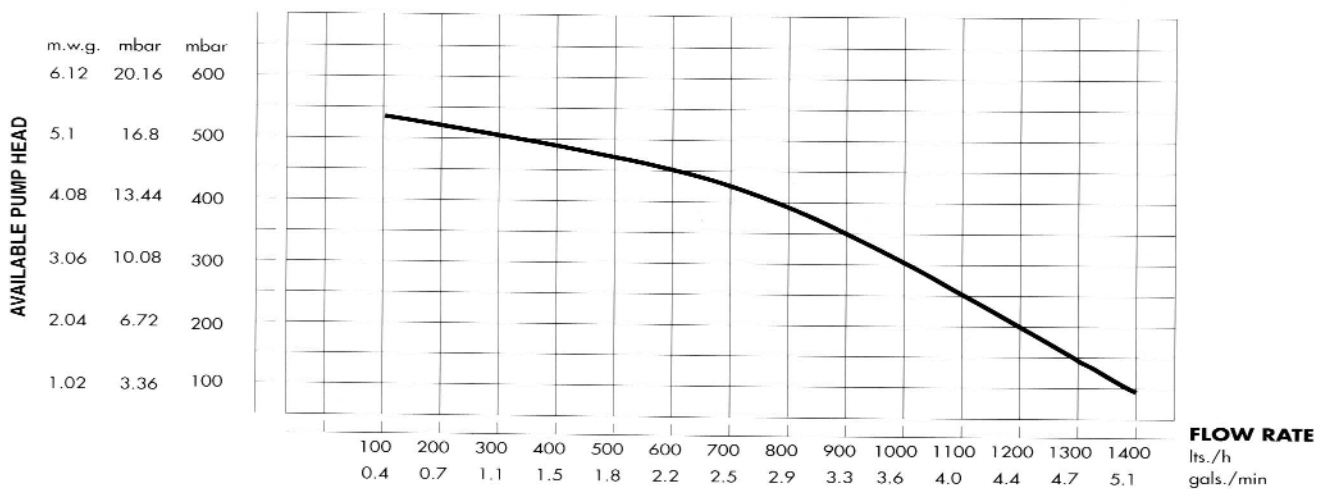

REGULATING HEATING POWER FOR NATURAL GAS (G20)

GB950092

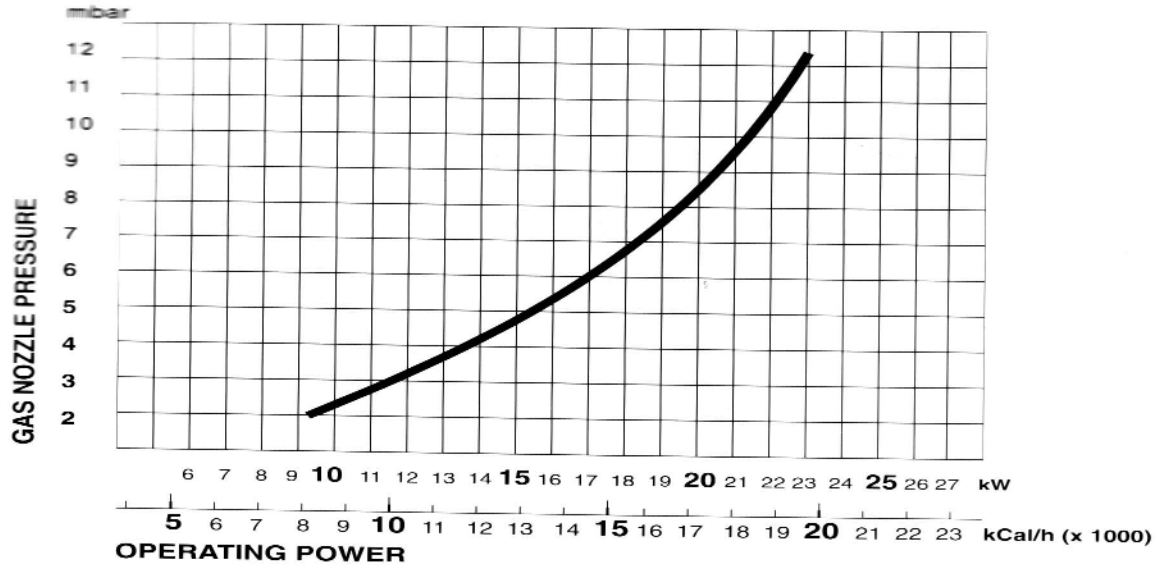

REGULATING HEATING POWER FOR BUTANE GAS (G30)

GB950093



REGULATING HEATING POWER FOR PROPANE GAS (G31)

GB950094

